

# *provitherm*

*28 kW wall hung combination boiler*

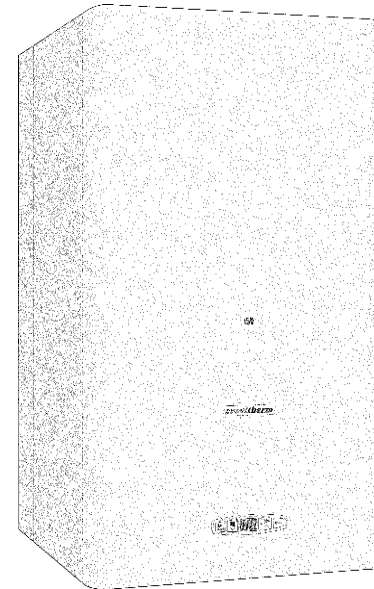

*User, Installation  
and Servicing Instructions*

XXXX



*This is a Cat II<sub>2H3+</sub> appliance*

5. April 2002

*Manufactured exclusively for Plumb Center by Hepworth Heating Division*

# Provitherm 28 KTV

**Note:** The boiler serial number is marked on the data label attached to the fascia behind the front panel. Refer to the 'Introduction' section for a description of the basic functions of the boiler. The 'User' section describes how to safely operate the boiler.

## Users' Instructions

Introduction .....	2
Controls and lighting .....	2
Draining and filling .....	8
Heating safety valve .....	8
Servicing/maintenance .....	8
Cleaning .....	8
Boiler casing .....	8

## Installation Instructions

Introduction .....	9
Technical data Provitherm 28 KTV .....	11
Dimensions .....	12
Pressure available .....	12
Boiler schematic .....	13
Installation section .....	14
Terminal positions .....	14
Heating and hot water system design .....	15
Boiler installation .....	18
Horizontal flue installation .....	18
Vertical flue installation .....	21
Flue configurations .....	22
Electrical connection .....	23
Commissioning .....	24

## Servicing Instructions

Routine cleaning and inspection .....	27
Replacement of parts .....	28
Schematic wiring diagram .....	33
Fault finding .....	34
Conversion to LPG .....	36

### Mandatory warning for CE countries

**WARNING**, these appliances were designed, approved and inspected to meet the requirements of the English market. The identification plate located on the inside of the appliance **certifies the origin** where the product was manufactured and the **country** for which it is intended.

If you see any exception to this rule, please contact your nearest stockist.

**Thank you in advance for your assistance.**

## USERS INSTRUCTIONS

The **Provitherm 28 KTV** is a wall mounted combination boiler providing central heating and instantaneous domestic hot water.

These instructions should be carefully followed for the safe and economical use of your boiler.

### Gas leak or fault

If a gas leak or fault exists or is suspected, turn the boiler and gas supply off and consult the local gas company or your Installer/Service provider.

### In case of power supply failure

The boiler no longer operates.  
As soon as power supply is restored, the boiler will restart automatically.

### In case of loss of water in the system

**CAUTION:** The boiler is installed as part of a sealed system which must only be drained and filled by a competent person.  
If the pressure LED diod (2) flashes the pressure in CH system is less than 0.8 bar and the system must be filled up immediately.

**Important notice:** A central heating system cannot operate satisfactorily unless it is properly filled with water and unless the air initially contained in the piping systems has been properly bled off. If these conditions are not satisfied, air noise will occur within the system and the boiler may fail to operate.

### Air in the heating system

Persistent air in the heating system may indicate leaks in the system or corrosion taking place. Call your Installer /Service provider.

### Overheating safety

In the event of problem, the overheat safety device causes safety shutdown of the boiler. If this happens, call your Installer/Service provider.

## CONTROLS AND LIGHTING

The control panel is located at the lower front of the boiler casing. The controls on this panel allow the boiler to be started, shut down, controlled and monitored during use, see diagram 1.

### The following information is displayed:

- Actual heating temperature (°C) - LED (3) lights on  
*displayed during standby*
- Actual domestic hot water temperature (°C) - LED (5) lights  
*displayed during hot water demand*
- System pressure (bar) – LED (2) lights  
*for 25 sec after Bar/Mode button is pressed*
- Diagnostic messages – displayed letter F and numbers from 0 to 4

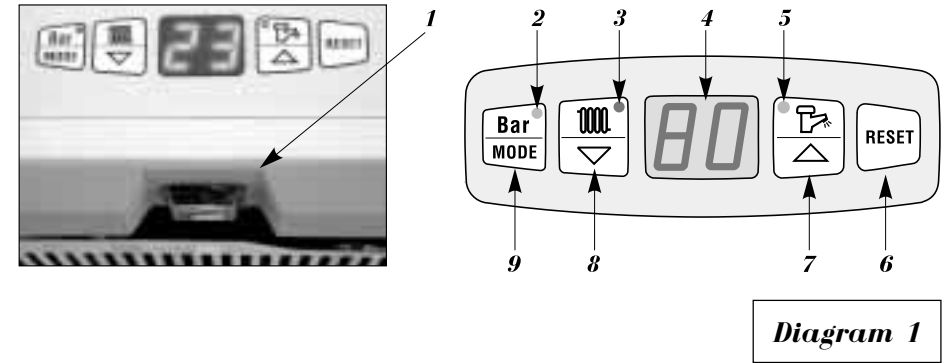

### Controls:

- |                            |                          |
|----------------------------|--------------------------|
| 1 – mains on/off switch    | 6 – reset button         |
| 2 – system pressure LED    | 7 – increase button      |
| 3 – central heating LED    | 8 – decrease button      |
| 4 – display                | 9 – pressure/mode button |
| 5 – domestic hot water LED |                          |

### The Bar/Mode button functions

- 1<sup>st</sup> press of button – the system pressure is displayed in bar  
*LED (2) lights*
- 2<sup>nd</sup> press of button – hot water adjusting mode  
*LED (5) flashes*
- 3<sup>rd</sup> press of button – heating water adjusting mode  
*LED (3) flashes*
- 4<sup>th</sup> press of button – reverts to standby mode

### To start the boiler

Switch on the mains switch (display will light up). The version of the software used is displayed for 2 sec.

### To stop the boiler

Switch off the mains switch (display will go out)  
If the boiler is to be out of operation for a long period, turn off the gas service cock.

### Boiler setting

All parameters are adjustable by means of 3 buttons, pushing the RESET button restarts the boiler.

**Note:** Buttons must be pressed in the middle.

### Make sure that:

- The boiler is connected to the electrical supply.
- The boiler gas service cock is open.
- The CH system is filled up and pressurized between 1 and 2 bar.

The boiler is now ready to start.

### Domestic hot water setting

- Press Bar/Mode button until LED (5) flashes.
- Using buttons (7) and (8) set the desired hot water temperature  
*Setting steps: 40, 42, 45, 48, 50, 52, 55, 58, 60 °C*
- Set '– –' if hot water is not required.
- Press Bar/Mode button to save new setting.

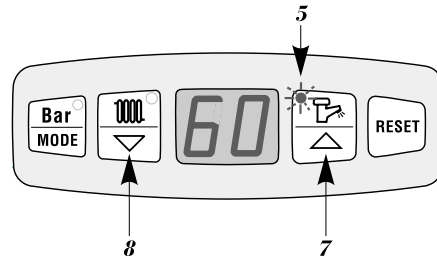

### Heating setting / summer mode setting

- Press Bar/Mode button until LED (3) flashes.
- Using buttons (7) and (8) set the desired heating temperature  
*Setting steps: 45, 50, 55, 60, 65, 70, 75, 80, 85 °C*
- Set '– –' if only hot water is required (summer mode).
- Press Bar/Mode button to save new setting.

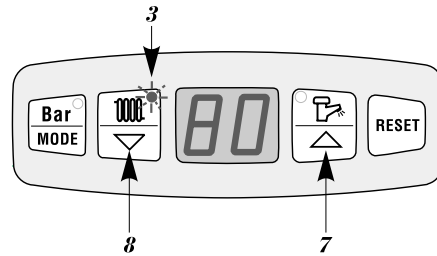

The heating will operate according to the requirements of the timeclock and/or room thermostat if fitted or, will operate according to the system requirements. Domestic hot water (DHW) always has priority over central heating (CH).

**Note:** All new settings are stored by pressing Bar/MODE button. If Bar/MODE button is not pressed for 20 sec the display reverts to standby mode and old settings are retained.

### Helpfull hint

If you get confused and wish to start again, switch boiler off, press and hold button (8) and switch boiler on by main switch. The boiler will revert to the internal factory set programme (heating temperature 80 °C, hot water temperature 50 °C, maximum heat output).

### Weather comp. control - curve slope

Push the Bar/MODE button. Code „E“ + a number between 1 and 9, or a dash, is displayed. The curve is selected by buttons (8) and (7) – the higher the number in the code, the higher the curve slope, cf. Diagram 1.

**Note:** If we want to use the weather comp. control, an external sensor must be connected and the boiler must not be in the SUMMER operational mode. If no external sensor is connected, the F5 defect code is displayed!

The value is set in the memory by pushing the Bar/MODE button and activating the following mode.

### Weather comp. mode – curve parallel shift

Push the Bar/MODE button. Code „P“ + a number between 1 and 9, or a dash, is displayed. The required shift, or „P–“ for no shift, is selected by buttons (8) and (7) as follows:

P–	..... without a shift	P5	..... +3°C
P1	..... –15°C	P6	..... +6°C
P2	..... –9°C	P7	..... +9°C
P3	..... –6°C	P8	..... +15°C
P4	..... –3°C	P9	..... +21°C

The values with the minus sign are deducted from the HCW temperature (and the values with the plus sign are added to it) determined by the weather comp. curve in dependence on the outside temperature.

### Example:

- Let the selected curve slope be E6, and the outside temperature be –10°C, for which the CHW temperature determined by the E6 curve is 73°C.
- If the P3 shift is selected (i.e., by –6°C), the resulting CHW temperature is 73 – 6 = 67°C.

The value is set in the memory by pushing the Bar/MODE button and activating the following mode.

### Diagram of mode setting

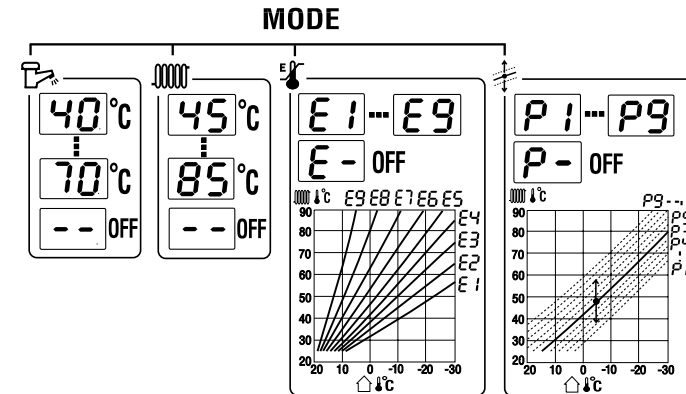

### Example:

- Let the selected curve slope be E6, and the outside temperature be –10°C, for which the CHW temperature determined by the E6 curve is 73°C.
- If the P3 shift is selected (i.e., by –6°C), the resulting CHW temperature is 73 – 6 = 67°C.

The value is set in the memory by pushing the Bar/MODE button and activating the following mode.

### Safety lockout

In the event of a safety lockout, the digital display will show 'F1'. Reset boiler by pressing the RESET button.

**IMPORTANT:** If safety lockout occurs frequently, or if any other fault is indicated, contact your Installer/Service Provider.

## DRAINING AND FILLING

**CAUTION:** The boiler is installed as part of a sealed system which must only be drained and filled by a competent person.

If the pressure drops to 0.8 bar the pressure LED on the Bar/MODE button starts to flash. The boiler will continue to work, but the LED warns that pressure in the CH system is on the low limit and CH system must be filled. To fill the system, open the tap on the filling loop below the boiler. Press the Bar/MODE button to read the system pressure. When the pressure is between 1 and 2 bar, close the tap.

**Note:** If there is persistent loss of system pressure, you must consult your Installer/Service Provider.

## HEATING SAFETY VALVE

**CAUTION:** A safety valve with a discharge pipe is fitted to this boiler.

The valve **MUST NOT BE TOUCHED** except by a competent person. If the valve discharges at any time, switch the boiler off and isolate it from the electrical supply. Contact your Installer/Service Provider.

## SERVICING/MAINTENANCE

To ensure the continued efficient and safe operation of the boiler, it is recommended that it is checked and serviced at regular intervals. The frequency of servicing will depend upon the installation conditions and usage but, in general, once a year should be enough.

## CLEANING

The boiler casing can be cleaned with a damp cloth followed by a dry cloth to polish. Do not use abrasive or solvent cleaners.

## BOILER CASING

**CAUTION:** Do not remove or adjust the casing in any way, as incorrect fitting may result in faulty operation.

If in doubt, contact your Installer/Service Provider.

## INSTALLATION INSTRUCTIONS

### INTRODUCTION

The Provitherm 28 KTV is a wall mounted combination boiler providing central heating and instantaneous domestic hot water.

The boiler is of the II<sub>2H3+</sub> category for use with Natural gas (G20) as distributed in the United Kingdom, or with Butane or Propane gas (G30/G31) with the appropriate conversion kit.

#### Conversion kit:

Conversion ..... Provitherm 28 KTV  
Natural gas (G20) to G30/G31 ..... SPB-28KTVJ

Modification must only be carried out by a suitably qualified engineer.

**Boilers burning LPG or similar gases MUST NOT be fitted in basements or below ground level.**

These instructions should be carefully followed for the safe and economical use of your boiler.

The boiler has a fan assisted, balanced, flue which both discharges the product of combustion to, and draws the combustion air from the outside of the building.

#### Accessories

A range of accessories are available including, vertical flue components. For further information, contact your nearest Plumb Center branch.

#### Gas Safety (Installation and Use) Regulations

In the interests and that of gas safety, it is the law that ALL gas appliances are installed and serviced in by a competent person in accordance with the above regulations.

#### Gas leak or fault

If a gas leak or fault exists or is suspected, turn the boiler and gas supply off and consult the local gas company or your Installer/Service Provider.

#### Boiler controls

The control panel, located at the lower front of the boiler, allows the boiler to be started, shut down, controlled and monitored during use, refer to '**Users Instructions**'.

# PROVITHERM 28 KTV – TECHNICAL DATA

CE Certification .....	n° .....	0063BL3573
Class .....	.....	II <sub>2H3+</sub>
Type .....	.....	C <sub>12</sub> , C <sub>32</sub>
Gas type .....	<b>G20</b> .....	<b>G30</b> .....
Max. / min. heat input .....	kW .....	30.3/13.1 .....
Max. / min. heat output .....	kW .....	27.6/11.0 .....

## EFFICIENCY (PCI)

Nominal efficiency .....	% .....	82.3
Efficiency at 30% load .....	% .....	80.5

## HEATING

Temperature range .....	°C .....	45 – 85
Expansion vessel .....	l .....	7
Expansion vessel pressure .....	bar .....	1
Max. working pressure .....	bar .....	3
Max. system temperature .....	°C .....	85
Max. system capacity .....	l .....	130

## HOT WATER

Flow rate at 30°C temperature rise .....	l/min .....	13.0
Flow rate at 35°C temperature rise .....	l/min .....	11.1
Min. water flow .....	l/min .....	2.7
Max. / min. supply pressure .....	bar .....	6 / 1
Temperature range .....	°C .....	40 – 60

## ELECTRICAL DATA

Voltage / frequency .....	V/Hz .....	~230 / 50
Current .....	A .....	0.63
Power .....	W .....	145
Level of protection .....	IP .....	IP X4D

## DIMENSIONS

Width / height / depth .....	mm .....	450 / 800 / 330
Weight .....	kg .....	40.5

## CONNECTIONS

Heating flow / return .....	mm .....	22
Domestic Water inlet / outlet .....	mm .....	15
Gas .....	mm .....	22
Flue products outlet / air inlet Ø .....	mm .....	horiz. 60/100, vert. 80/125
Horizontal flue length min. – max. ....	m .....	0.5 – 3
Vertical flue length min. – max. ....	m .....	1 – 9

## GAS SUPPLY PRESSURE

Burner pressure .....	mbar .....	2.5 – 14.0 .....
Nominal pressure .....	mbar .....	20 .....
Injectors diameter .....	Ø mm .....	1.2 .....

## GAS CONSUMPTION

Q max / Q min .....	m <sup>3</sup> /h .....	3.2/1.4 .....
Air flow .....	m <sup>3</sup> /h .....	135 .....

# DIMENSIONS AND PRESSURE AVAILABLE

## Provitherm 28 KTV

A	800
B	450
C	65
D	225
E	83
F	228
G	180
H	330
I	105
J	160
K	70

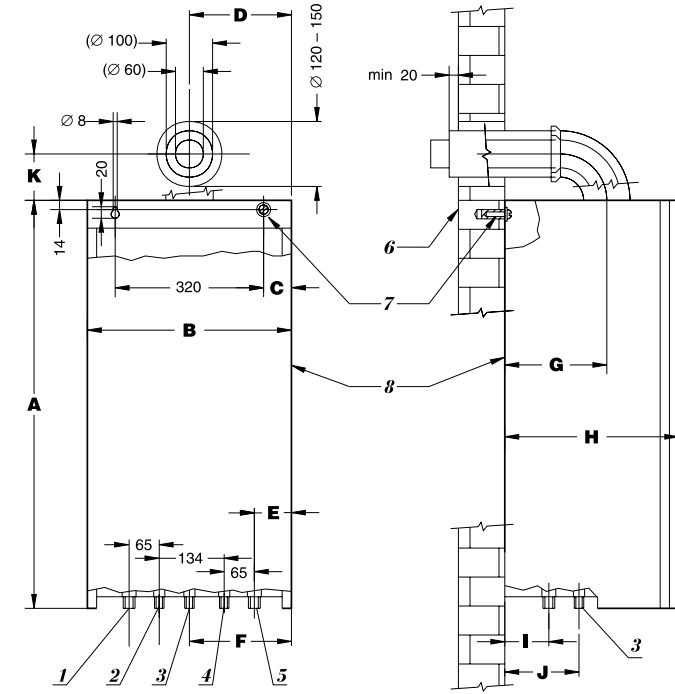

FRONT VIEW

Diagram 2

- 1 – Heating flow (pipe diameter 22 mm)
- 2 – Hot water outlet (pipe diameter 15 mm)
- 3 – Gas inlet (pipe diameter 22 mm)
- 4 – Cold water mains inlet (pipe diameter 15 mm)
- 5 – Heating return (pipe diameter 22 mm)
- 6 – Wall
- 7 – Wall fixings
- 8 – Outer cover

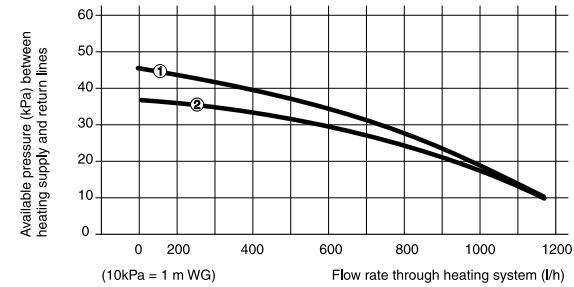

- ① Bypass fully shut
- ② Bypass open

Diagram 3

## BOILER SCHEMATIC

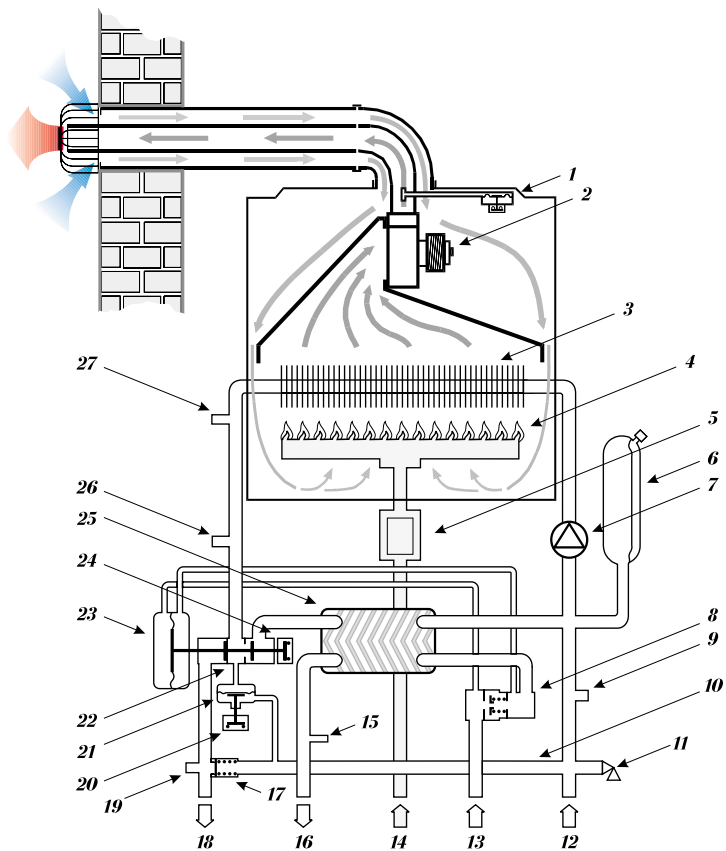

- |                                |                                    |
|--------------------------------|------------------------------------|
| 1 – Air pressure switch        | 15 – DHW thermistor                |
| 2 – Fan                        | 16 – DHW outlet                    |
| 3 – Heat exchanger             | 17 – Automatic by-pass             |
| 4 – Burner                     | 18 – Heating flow                  |
| 5 – Gas valve                  | 19 – Drain                         |
| 6 – Expansion vessel           | 20 – Microswitch                   |
| 7 – Pump                       | 21 – Loss of water pressure switch |
| 8 – Water flow sensor          | 22 – 3-way valve                   |
| 9 – Pressure gauge connection  | 23 – Differential valve            |
| 10 – By-pass pipe              | 24 – Microswitch                   |
| 11 – Safety valve              | 25 – Secondary heat exchanger      |
| 12 – Heating return            | 26 – CH temperature sensor         |
| 13 – Domestic cold water inlet | 27 – High limit thermostat         |
| 14 – Gas inlet                 |                                    |

**Diagram 4**

## INSTALLATION SECTION

### Clearances

To allow for servicing, the boiler should be installed with the following clearances:  
 50 mm either side of the boiler  
 600 mm to the front of the boiler  
 300 mm below the boiler  
 200 mm above the boiler

### TERMINAL POSITION

The minimum acceptable spacings from the terminal to obstructions and ventilation openings are shown in diagram 5 below:

**Minimum dimensions (in mm) for the positioning of flue terminals**

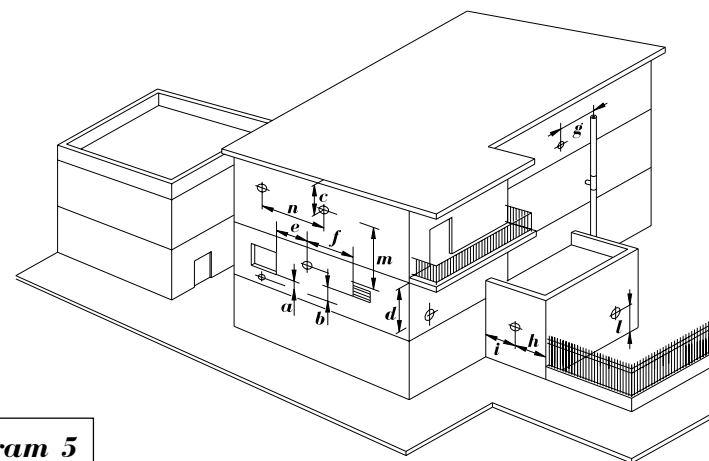

**Diagram 5**

a	Under a window . . . . .	300
b	Under an air vent . . . . .	300
c	Under a gutter . . . . .	75
d	Under a balcony . . . . .	300
e	From an adjacent window . . . . .	300
f	From an adjacent air vent . . . . .	300
g	From vertical drain pipes or soil pipes . . . . .	75
h	From an external corner of the building . . . . .	300
i	From an internal corner of the building . . . . .	300
l	From the ground or from another floor . . . . .	300
m	Between two terminals vertically . . . . .	1500
n	Between two terminals horizontally . . . . .	300

## HEATING SYSTEM DESIGN

The **Provitherm 28 KTV** is compatible with any type of sealed system installation, i.e. radiators, fan convectors etc.

Pipe sectional areas shall be determined in accordance with normal practices, using the pump curve, refer to '**Technical Data**'. The distribution system shall be calculated in accordance with the output requirements of the actual system, not the maximum output of the boiler. However, provision shall be made to ensure sufficient flow so that the temperature difference between the flow and return pipes is less than or equal to 20 °C. The minimum flow is **500 l/h**.

The piping system shall be routed so as to avoid any air pockets and facilitate permanent venting of the installation. Bleed fittings shall be provided at every high point of the system and on all radiators.

The total volume of water permitted for the heating system depends, amongst other things, on the static head in the cold condition. The expansion vessel on the boiler is pressurised at 1 bar (corresponding to a static head of 10 m wg.) and allows a maximum system volume of 130 litres for an average temperature of 75 °C and a maximum service pressure of 3 bar. This pressure setting can be modified at commissioning stage if the static head differs.

Provision shall be made for a drain valve at the lowest point of the system.

Thermostatic radiator valves are permitted, however, not all radiators must be fitted with this type of valve and particularly where the room thermostat is fitted.

A WRC approved filling loop is supplied with the boiler to enable correct filling of the system.

In all cases, it is **ESSENTIAL** that the system be thoroughly flushed prior to installing the new boiler.

### Domestic hot water system design

Copper tubing or plastic Hep2O may be used for the domestic hot water system. Unnecessary pressure losses should be avoided. The domestic hot water supply pressure must be between 1 and 6 bar. If the pressure exceeds 6 bar, a pressure reducing valve must be fitted. In known hard water areas, it is recommended that a suitable scale reducing device is fitted to the cold water supply to the boiler.

### Boiler connections

- A Heating flow
- B Hot water outlet
- C Gas connection
- D Cold water mains inlet
- E Heating return
- F Safety valve discharge connection

### Heating system connections

- Pipe diameter 22 mm.

### Hot water system connections

- Pipe diameter 15 mm.

### Gas connection

- Pipe diameter 22 mm.

### Safety valve discharge connection

- Pipe diameter 22 mm.

**Note:** White colored washers must be used for the hot water system connections.

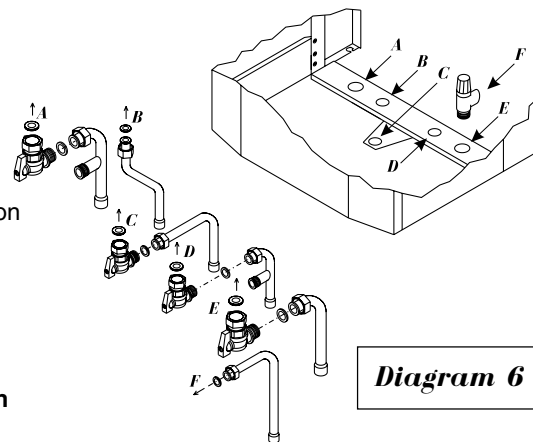

Diagram 6

### Safety valve discharge

**WARNING:** It must not discharge above an entrance or window or any type of public access area.

Connect the safety valve discharge pipe to the valve, the discharge must be extended using not less than 15 mm o.d. pipe, to discharge in a visible position outside the building, facing downward, preferably over a drain. The pipe must have a continuous fall and be routed to a position so that any discharge of water, possibly boiling or steam, cannot create any danger to persons, damage to property or external electrical components and wiring. Tighten all pipe connection joints.

### Gas connection

The supply from the governed meter must be of adequate size to provide a constant inlet working pressure of 20 mbar for Natural gas (28 – 30 mbar for Butane or 37 mbar for Propane).

To avoid low pressure problems, it is recommended that the supply is taken to the boiler using 22 mm pipe as far as possible.

On completion, the gas installation must be tested using the pressure drop method and purged in accordance with the current issue of BS6891.

### Gas Safety (Installation and Use) Regulations

In your interests and that of gas safety, it is the law that **ALL** gas appliances are installed and serviced by a competent person in accordance with the above regulations.

### Statutory requirements

The installation of this boiler must be carried out by a competent person in accordance with the relevant requirements of the current issue of:

- The Gas Safety (Installation and Use) Regulations
- The Building Regulations
- The local water company Bylaws
- The Building Standards Regulations (Scotland)
- The Health and Safety at Work Act

### Sheet metal parts

**WARNING:** When installing or servicing this boiler, care should be taken when handling the edges of sheet metal parts to avoid the possibility of personal injury.

### Installing the boiler

Prior to installing the boiler, the system must be thoroughly flushed to eliminate any foreign bodies and contaminants such as filings, solder, particles, oil, grease etc.

**Note:** Solvent products could cause damage to the system.



## BOILER INSTALLATION

To install the boiler, proceed as follows:

- Allowing sufficient clearances for servicing/repair, place the template on the wall.

**Note:** The boiler can be installed only on the closed wall.

- Determine the position of the flue hole and drill hole for flue, preferably using a 120 mm core drill.
- Drill two **10 mm** holes for the wallplugs supplied.
- Screw fixing screws supplied into wallplugs, leave proud by approx. 10 mm.

**Note:** Boiler fixing holes are keyhole type slots at the top of the boiler to allow easy hanging of boiler.

- It is recommended to fit the safety discharge pipe before hanging the boiler on the wall.
- Hang the boiler on the screws and tighten screws.

**Note:** As a option the hanging bracket can be used. Two screws are sufficient for fixing of the hanging bracket. Hanging bracket fixing screws have to be fully tight before the boiler is hung on.

### Pipework connections

- Remove plastic caps from boiler connections.
- Connect the central heating pipework connections and isolating cocks as shown on diagram 6.
- Connect the domestic cold water inlet connection and isolating cock.
- Connect the hot water outlet connection.
- Connect the gas connection and isolating cock.
- Finally, connect the filling loop between the cold water inlet pipe and the heating flow pipe.

## HORIZONTAL FLUE INSTALLATION

- A Air inlet pipe
- B Terminal
- C Seal and clamp
- D Elbow
- E Gasket
- F Screws
- G External rubber sealing collar
- I Internal plastic collar
- J 'O' rings

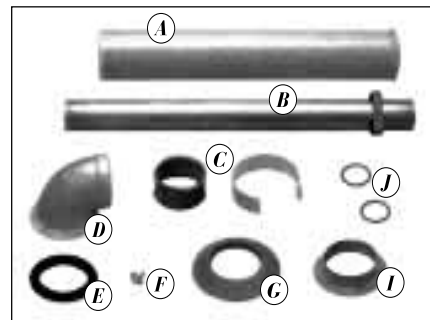

**Diagram 7**

- Fit gasket (E) onto underside of flue elbow (D) - see diagram 8.
- Carefully insert 'O' ring (J) into upper and lower parts of inner elbow.
- Fit elbow onto spacer ensuring elbow inner connection locates correctly onto fan outlet.
- Fit external rubber sealing collar (G) onto air inlet pipe (A).

**Diagram 8**

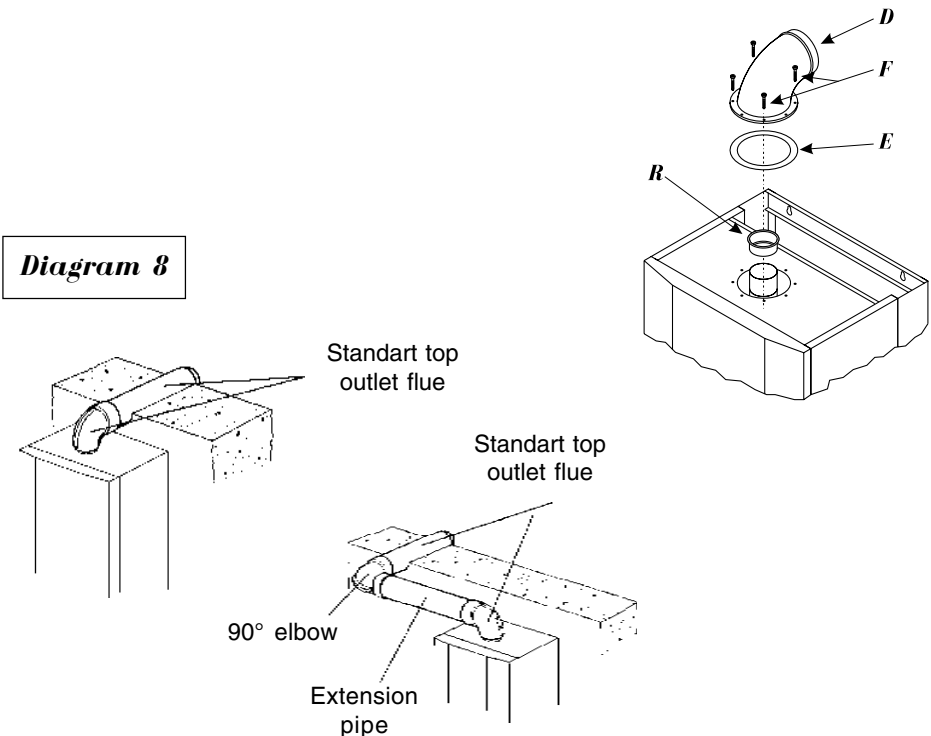

- Fit flue through hole in wall and pull up so that external collar (G) is flush against outside wall.
- Fit seal and clamp (C) to flue and assemble into elbow (D) making sure that both inner and outer pipes are sealed properly.

**Note:** Maximum horizontal length with no bends is 3 m. For horizontal flue lengths up to 1 m the restrictor must be left in the fan outlet, see diagram 8. For horizontal flue lengths between 1 and 3 m remove the restrictor (R).

- Tighten up clamp using screws provided.

**Note:** Should it be necessary to cut the flue, always cut equal amounts from both inner and outer pipes.

Always cut the end furthest from the terminal.

**For each 90° flue bend fitted, reduce overall flue length by 1 m.**

**For each 45° flue bend fitted, reduce overall flue length by 1/2 m.**

### Horizontal flue kit

#### Flue extension kit

#### 90° concentric bend kit

#### 45° concentric bend kit

## VERTICAL FLUE INSTALLATION

- Fit gasket (E) onto underside of vertical adaptor (O) – see diagram 9.
- Carefully insert 'O' ring (J) into vertical adaptor inner spigot.
- Fit vertical adaptor (O) ensuring adaptor inner connection locates correctly onto fan outlet.
- Fit extension pipes (M) as required.
- For pitch roof installation, fit pitch roof flashing.
- Fit flue terminal (L) onto roof ensuring flashing makes a watertight joint.

**Note:** Maximum vertical height with no bends is 9 m.  
 Should it be necessary to cut the flue, always cut equal amounts from both inner and outer pipes.  
 Connect condensate trap (supplied) to vertical flue adaptor when flue length exceeds 3 m.  
 Connect 15 mm plastic pipe (not supplied) to a suitable drain.  
 For vertical flue lengths up to 4 m the restrictor must be left in the fan outlet, see diagram 8.  
 For vertical flue lengths between 4 and 9 m, remove the restrictor (R).

For each 90° flue bend fitted, reduce overall flue height by 1 m.  
 For each 45° flue bend fitted, reduce overall flue height by 1/2 m.

Roof terminal (black)  
 Pitched roof flashing  
 Flue extension pipe  
 90° concentric bend kit  
 45° concentric bend kit  
 flue outlet adaptor c/w condensate trap

**Diagram 9**

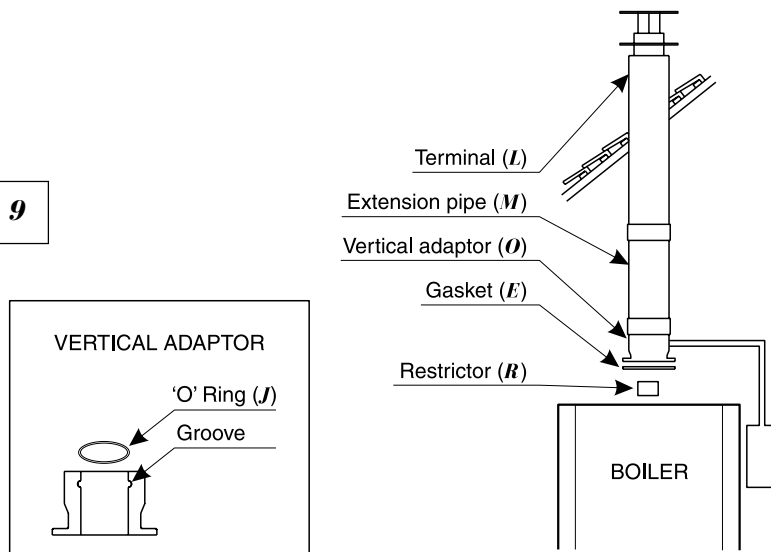

## FLUE CONFIGURATIONS

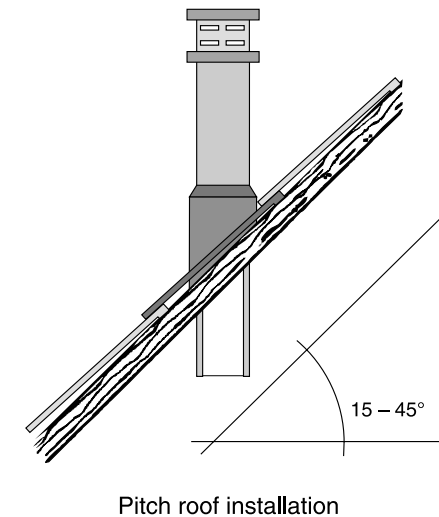
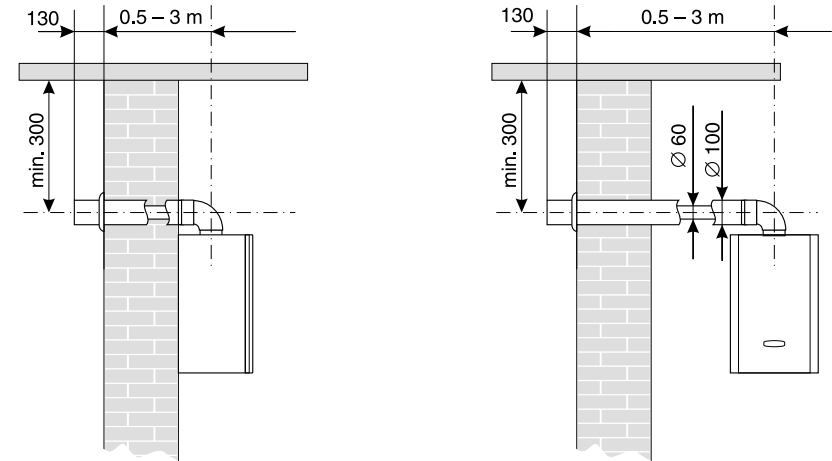

**Diagram 10**

## ELECTRICAL CONNECTION

**Warning:** This boiler must be earthed.

All system components must be of an approved type.

Connection of the whole electrical system and any heating system controls to the electrical supply must be through a common isolator.

Isolation should preferably be by a double pole switched fuse spur box having a minimum contact separation of 3 mm on each pole. The fused spur box should be readily accessible and preferably adjacent to the boiler. It should be identified as to its use.

A fused three pin plug and shuttered socket outlet may be used instead of the fused spur box, provided that:

- a) They are not used in a room containing a bath or shower.
- b) Both the plug and socket comply with the current issue of BS1363.

The mains electrical supply must be maintained at all times in order to provide domestic hot water and frost protection.

It is recommended that a room thermostat is fitted.

Thermostatic radiator valves may be installed in addition to the room thermostat.

**Note:** For further information, see The Building Regulations 1991 - Conservation of fuel and power - 1995 edition - Appendix G, table 4b.

### DO NOT INTERRUPT THE MAINS SUPPLY TO THE BOILER WITH A TIME SWITCH OR PROGRAMMER.

The **Provitherm 28 KTV** is delivered with 1 metre mains supply lead ready connected. The electrical supply cable is the original spare part and must be replaced only by original supply cable for PROVITHERM 28 KTV boiler.

**Warning:** If the supply cord is damaged, it must be replaced by the Installer/Service provider to avoid a hazard.

### External controls

The boiler will work for heating **AS DELIVERED** without a room thermostat fitted provided the two wires on the integral external controls connection **REMAIN LINKED TOGETHER** (as supplied). If a room thermostat is required, it must be connected as shown below and the link must be removed.

**ANY ROOM THERMOSTAT USED MUST BE OF THE VOLTAGE FREE TYPE.**

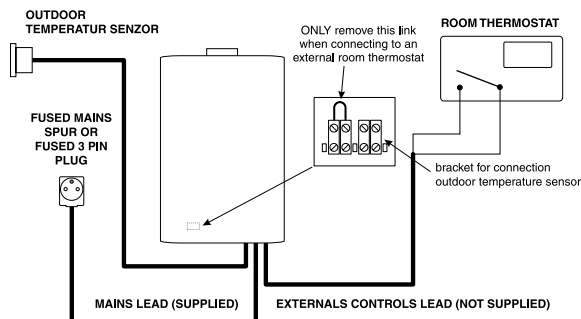

Diagram 11

**WARNING: ON NO ACCOUNT MUST ANY ELECTRICAL VOLTAGE BE APPLIED TO EITHER OF THE TERMINALS OF THE EXTERNAL CONTROLS CONNECTION**

**WARNING:** This boiler must be wired in accordance with these instructions. Any fault arising from incorrect wiring cannot be put right under the terms of the guarantee.

## COMMISSIONING

**The commissioning and first firing of the boiler must only be carried out by a competent person.**

To gain access to the inside of the boiler undo screw securing front panel at the boiler bottom, remove front panel by pulling forwards, lifting it up and off. Note – upper edge of front casing is fixed to the boiler by means of 2 pins.

### Filling the system

- Check that the gas meter tap is closed.
- Connect boiler to electrical supply.
- Place switch (1) diagram 1 to position 'I' FO is displayed and the pump runs for about one minute.
- Press the BAR/Mode button, see diagram 1. Value of system pressure (0.0) is displayed and LED (2) – see diagram 1 – lights.

**Note:** The pressure is displayed for about 25 sec. After this time the display comes back to the standby mode. The pressure can be displayed after pressing Bar/Mode push button again.

- Open isolating valves (**A, E** and **D**) see diagram 6.
- Undo, but not remove, cap on automatic air vent on the top of the pump.
- Fill system by opening system filling loop until a pressure of between 1 and 2 bar is shown on the display.
- Bleed each radiator until a continuous jet of water is obtained.
- Do not retighten automatic air vent cap.
- Open various hot water taps to bleed hot water circuit.
- Make sure that pressure is between 1 and 2 bar. Re-pressure as necessary.

**Important:** When venting air from boiler, do not touch the schrader valve on the expansion vessel, it is NOT a vent.

### Starting the boiler

Before starting the boiler check that:

- The gas meter tap is open.
- The boiler gas service cock is open.
- The water isolating cocks are open.
- The boiler is connected to the electrical supply.

### First starting up

- Place main switch (1) diagram 1 to position 'I'
- Set maximum heating water temperature (85°C), as described in 'Users Instructions' and check that any external controls, if fitted, are calling for heat.
- Allow the temperature to rise to the maximum value, with all radiator valves open. Air contained in the water of central heating system will be automatically released through the automatic air vent. Air trapped at the highest point of the system must be released by bleeding the radiators.

On reaching maximum temperature, the boiler should be turned off and the system drained as rapidly as possible whilst still hot.

- Refill system to a pressure at least of 1 bar and vent as before.
- Restart boiler and operate until a maximum temperature is reached. Shut down boiler and vent air from heating system. If necessary, top up heating system and make sure that a pressure at least of 1 bar is indicated on the display when system is COLD.

### Gas installation

It is recommended that any air is purged from the supply at the gas inlet test point on the gas valve, see diagram 12.

- 1 - Inlet test point
- 2 - Outlet test point

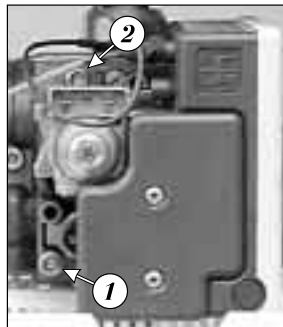

Diagram 12

### Gas pressures

- Shut down boiler.
- Undo screw on gas inlet test point '1' on gas valve, see diagram 12.
- Connect a suitable pressure gauge.
- Start boiler as described in 'Users Instructions'.
- Check that there is a constant pressure of 20 mbar for Natural gas (28 – 30 mbar for Butane or 37 mbar for Propane). If the pressure is insufficient, it is necessary to check the gas supply/pipework and correct any fault.
- Shut down boiler.
- Remove pressure gauge, tighten up carefully test point screw and check for gas soundness.

### Setting the central heating output

The central heating output must be set in accordance with the system requirements.

Setting procedure as follows:

- Push and hold the Bar/Mode button for at least 8 sec. The display will switch to service mode, the symbol n- will be displayed
- Set the desired output value from n1 to n9 by means of buttons (7) and (8) according to the following table:

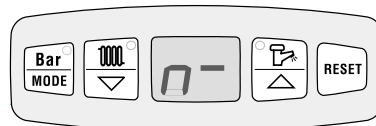

Diagram 13

### HEAT OUTPUT

	Provitherm 28 KTV	
	kW (Btu/hr)	
n1	11.0	(37 532)
n2	13.0	(44 356)
n3	16.0	(54 592)
n4	18.0	(61 416)
n5	20.0	(68 828)
n6	22.0	(75 064)
n7	24.0	(81 888)
n8	26.0	(88 712)
n9	27.6	(94 171)
n-	27.6	(94 171) .. max. output

- Press Bar/Mode button to save and return to main menu.

### Safety devices

#### Air flow rate safety device

If an obstruction, even partial, of the flue occurs, the built in safety system of the boiler will turn the boiler OFF. The boiler will be ready to operate when the fault has been cleared.

#### In case of power supply failure

The boiler no longer operates. As soon as power is restored, the boiler will be automatically restarted. If the boiler does not restart, the overheat device may need resetting.

#### Overheat safety

In the event of overheating, the overheat safety device causes safety shutdown of the boiler. The digital display will show error code F1. To reset, let the boiler cool down, press the reset button on the safety device (a), see diagram 20 and reset boiler controls by means of the reset button (6).

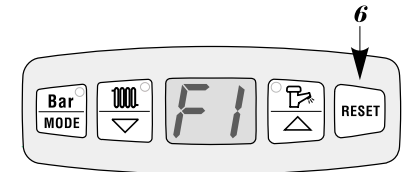

Diagram 14

**Note:** wire connections to overheat thermostat are mains voltage.

#### Important notice

A central heating system cannot operate satisfactorily unless it is properly filled with water and unless the air initially contained in the pipework system has been properly bled off. If these conditions are not satisfied, air noise will occur within the system and the boiler may fail to operate.

To reset the boiler (other than for overheating) use the reset button on the fascia, see diagram 14.

The **Provitherm 28 KTV** boiler has a built-in frost protection device that protects the boiler during freezing conditions. This device works irrespective of any room thermostat setting and only protects the boiler.

Should the temperature within the central heating circuit of the boiler fall below 10 °C, the pump will switch on providing the electrical supply has been left connected. If the temperature falls below 8 °C, then the burner will operate until the water temperature increases to 25 °C. Should the electrical supply have been disconnected and the boiler/system has frozen, the boiler will not start up until the boiler/system has been cleared.

## SERVICING INSTRUCTIONS

To ensure the continued efficient and safe operation of the boiler, it is recommended that it is checked and serviced at regular intervals. The frequency of servicing will depend upon the installation conditions and usage but, in general, once a year should be enough.

It is the law that any servicing is carried out by a competent person.

### ROUTINE CLEANING AND INSPECTION

- Operate boiler and check for any faults that need to be put right.
- Isolate boiler from the gas and electrical supplies.
- On completion check all gas carrying parts for soundness with leak detection fluid.

#### Remove boiler casing as follows:

##### Outer casing

- Undo screw securing the casing underneath boiler and remove outer casing by pulling forwards, lifting it up and off.

##### Sealed chamber

- Unclip two clips holding sealed chamber cover to boiler, unscrew two screws in middle of the cover and lift it forwards and off.

##### Side covers

- Undo 3 screws securing each of side covers and remove outer covers by pulling to side, forwards and off.

##### Cleaning the burner

- Undo and remove 6 screws securing combustion chamber cover and remove cover.
- Disconnect flame sense electrode at burner.
- Disconnect ignition lead at gas valve module.
- Disconnect ignition earth lead.
- Undo nuts (A) securing gas supply pipe between burner and gas valve and remove pipe, see diagram 16.

- Note:** The washer between the burner and burner gas supply must be kept to use on reassembly.
- Unscrew 2 screws (B) securing burner to base of sealed chamber.
  - Pull main burner up and forward out of boiler.
  - Examine and clean burner as necessary.

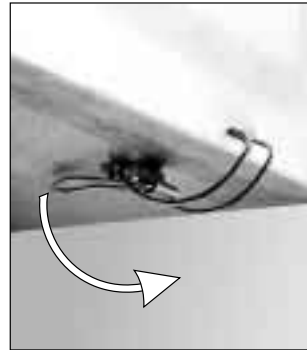

Diagram 15

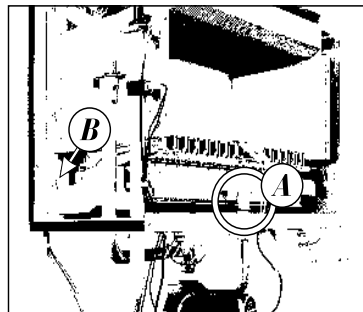

Diagram 16

**Note:** DO NOT use a wire or sharp instrument on the holes.

##### Heat exchanger

- Locate the heat exchanger inside the sealed chamber.
- Gain access to heat exchanger by removing fan and flue hood.
- Examine heat exchanger for any blockages or build up of deposits.
- Clean heat exchanger with soft brush or vacuum cleaner.

##### Reassembly of parts removed for servicing

All parts are replaced in reverse order to removal.

##### Flue system

- Check externally to make sure that flue is not blocked.
- Inspect flue system to make sure that all fittings are secure.

##### Operation of fan

- Switch on electrical supply and turn on gas.
- Remove sealed chamber cover.
- Light burner by operating external controls (if fitted) to call for heat.
- Check that fan operates when burner lights and stops when it goes out.

### REPLACEMENT OF PARTS

To gain access to the boiler components, proceed as follows:

- Isolate boiler from electrical supply.
- Remove outer case, if necessary sealed chamber cover, combustion chamber cover and side covers, see 'Routine cleaning and inspection'
- Gently squeeze metal clip securing the control panel box, lift it up and hinge down.

##### To replace fan

- Disconnect power supply and earth leads to fan.
- Supporting fan, unscrew and remove screw (A) securing fan.
- Gently ease fan by pushing down and out of boiler.
- Fit replacement fan in reverse order to removal making sure that mounting plate engages correctly onto flue hood

**Important:** Ensure that fan outlet is correctly fitted into flue elbow at top of boiler.

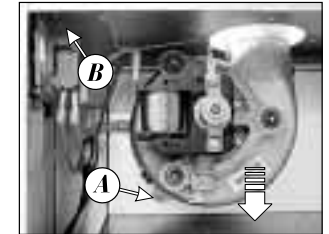

Diagram 17

##### To replace air pressure switch

- Locate air pressure switch in upper left hand corner of sealed chamber.
- Pull off clear plastic tube from base of switch.
- Remove electrical connections from the switch.

**Important:** Mark the connectors – it is necessary they have to be connected in the same position.

- Unscrew and remove two screws securing switch to upper panel and remove switch.
- Fit replacement switch in reverse order to removal.
- Fit electrical connections to replacement switch.
- Refit clear plastic tube to switch connection L.

**Note:** If the fan will not run after switch on the boiler, the order of connections is probably incorrect.

### To replace gas valve module

- Locate gas valve module attached to side of gas valve, see diagram 18.
- Unscrew screws (a) and (b) securing cover onto gas valve module.
- Remove cover and disconnect multi-plug from module.
- Disconnect ignition and flame sense leads from module and withdraw module from gas valve.
- Fit replacement module in reverse order to removal.
- Reconnect ignition and flame sense leads, the connections are uniquely sized to ensure correct replacement.
- Refit cover ensuring all sealing grommets are correctly located in module body.

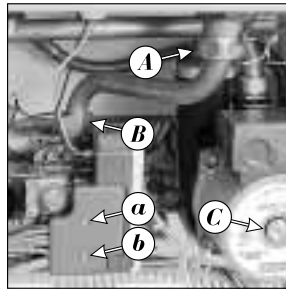

Diagram 18

### To replace gas valve

- Ensure that gas supply is turned off at gas cock.
- Unscrew screw (a) and remove gas valve module.
- Undo nuts securing gas supply pipe between burner and gas valve and remove pipe, taking care not to lose sealing washers, see diagram 18.
- Remove gas inlet connection to boiler.
- Unscrew 2 screws securing gas valve to boiler bottom.
- Remove gas valve by lifting upwards and out of boiler.
- Fit replacement gas valve in reverse order to removal.
- Check for gas-tightness.

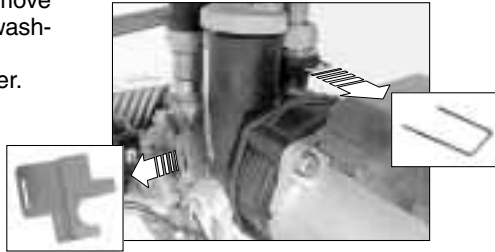

Diagram 19

### To replace burner

- Remove burner as described in 'Cleaning the burner'.
- Fit replacement burner in reverse order to removal.
- Check if the injectors are correct.

### To replace pump

Drain down heating circuit only of boiler as follows:

- From below boiler, close isolating valves on flow and return connections to boiler.
- Open boiler drain valve on left hand side of hydraulic block.

**Note:** It is not necessary to drain down entire heating circuit to carry out this work.

**Simplification:** for simpler work remove gas valve module and right side cover.

- Disconnect pump cable.
- Remove 2 clips fixing pump, see diagram 19.
- Unscrew 2 screws securing the pump to boiler bottom.
- Lift up the pipe and remove pump by lifting forward and out of boiler.
- Fit replacement pump in reverse order to removal.
- Open isolating valves on flow and return connections,
- Refill, vent and pressurise boiler. Check for leaks.

### To replace safety valve

- Drain down heating circuit of boiler as described previously.

**Simplification:** for simpler work remove gas valve module and pump as described previously.

- Remove expansion vessel hose from hydraulic block.
- Remove draining pipe from safety valve and unscrew safety valve.
- Fit replacement safety valve in reverse order to removal.

**Important:** Seal the safety valve thread by jointing compound.

### To replace domestic heat exchanger

- Drain down heating circuit of boiler as described previously.

Drain down hot water circuit of boiler as follows:

- From below boiler, close cold water inlet isolating valve.
- Open a hot tap to drain hot water circuit.
- Remove gas valve.
- Unclip pump and pull forwards.
- Disconnect expansion flexible hose at connection to vessel fixing.
- Remove fixing screws and plate exchanger over hydraulic block.
- Fit replacement heat exchanger in reverse order to removal, ensuring seals are correctly positioned in hydraulic block.
- Open isolating valves on flow and return connections, refill, vent and pressurise boiler. Check for leaks.
- Open cold water isolating valve. Check for leaks.

### To replace overheat thermostats

**Important:** Isolate boiler from electrical supply before this operation – connections to overheat thermostats are mains voltage.

- Locate overheat thermostat (a) to left hand side of sealed chamber, see diagram 20.
- Unclip thermostat from pipe.
- Pull off electrical connections from thermostat.
- Fit replacement thermostat in reverse order to removal.

**Note:** No heat sink compound is required. The polarity of the connections is not important.

### To replace heating water thermistor

- Locate thermistor (b) clipped onto flow pipe to left hand side of sealed chamber below overheat thermostat, see diagram 20.
- Unclip thermistor from pipe.
- Pull off electrical connections from thermistor.
- Fit replacement thermistor in reverse order to removal.

**Note:** No heat sink compound is required.

The polarity of the connections is not important.

### To replace hot water thermistor

- Pull off electrical connections from thermistor and unscrew thermistor from left part of hydraulic block.
- Remove gas valve module as described previously.
- Fit replacement thermistor in reverse order to removal.

**Note:** The polarity of the connections is not important.

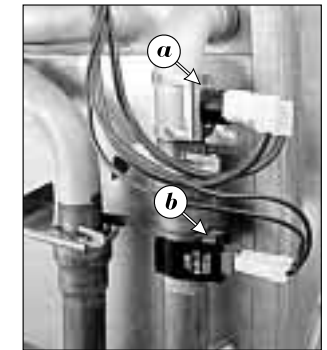

Diagram 20

### To replace printed circuit board (PCB)

**Important:** Isolate boiler from electrical supply before this operation.

- Gently squeeze metal clip securing the control panel box, lift it up and hinge down.
- From behind control panel box, unscrew and remove 4 screws securing PCB cover to panel.
- Pull off electrical plugs from PCB.
- Remove 4 screws securing PCB to panel and lift out PCB.
- Fit replacement PCB in reverse order to removal.

### To replace display and control panel board

**Important:** Isolate boiler from electrical supply before this operation.

- Remove PCB cover as described in 'To replace PCB'.
- Pull off electrical plug of display (A) from PCB, see diagram 21.
- Remove 4 screws securing PCB to panel and lift out PCB.
- Remove 4 screws securing display and control panel board to panel and gently lift it out.
- Fit replacement display and control panel board in reverse order to removal.

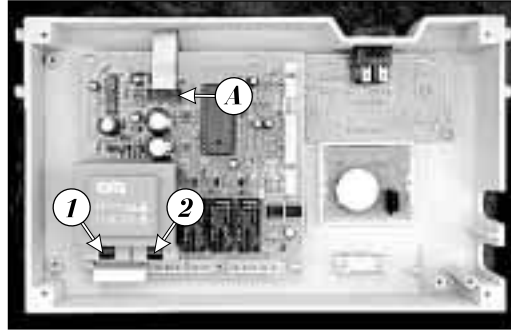

Diagram 21

### To replace pressure gauge

• Drain boiler as described in 'To replace pump'

- Unclip pressure gauge clip and pull it out.
- Disconnect pressure gauge cable.
- Fit replacement pressure gauge in reverse order to removal.

### To replace heat exchanger

- Drain down heating circuit of boiler only as described previously.
- Remove sealed and combustion chamber covers and side cases as described previously.
- Remove overheating thermostats from heat exchanger pipes.
- Pull off spring clips securing heat exchanger pipes to heat exchanger.
- Manoeuvre heat exchanger pipes down to disengage from heat exchanger.
- Gain access to heat exchanger by removing fan and flue hood.
- Remove heat exchanger by sliding forward and out of boiler.

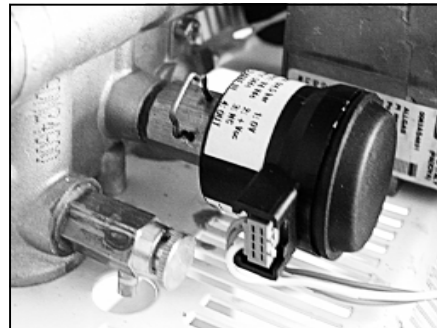
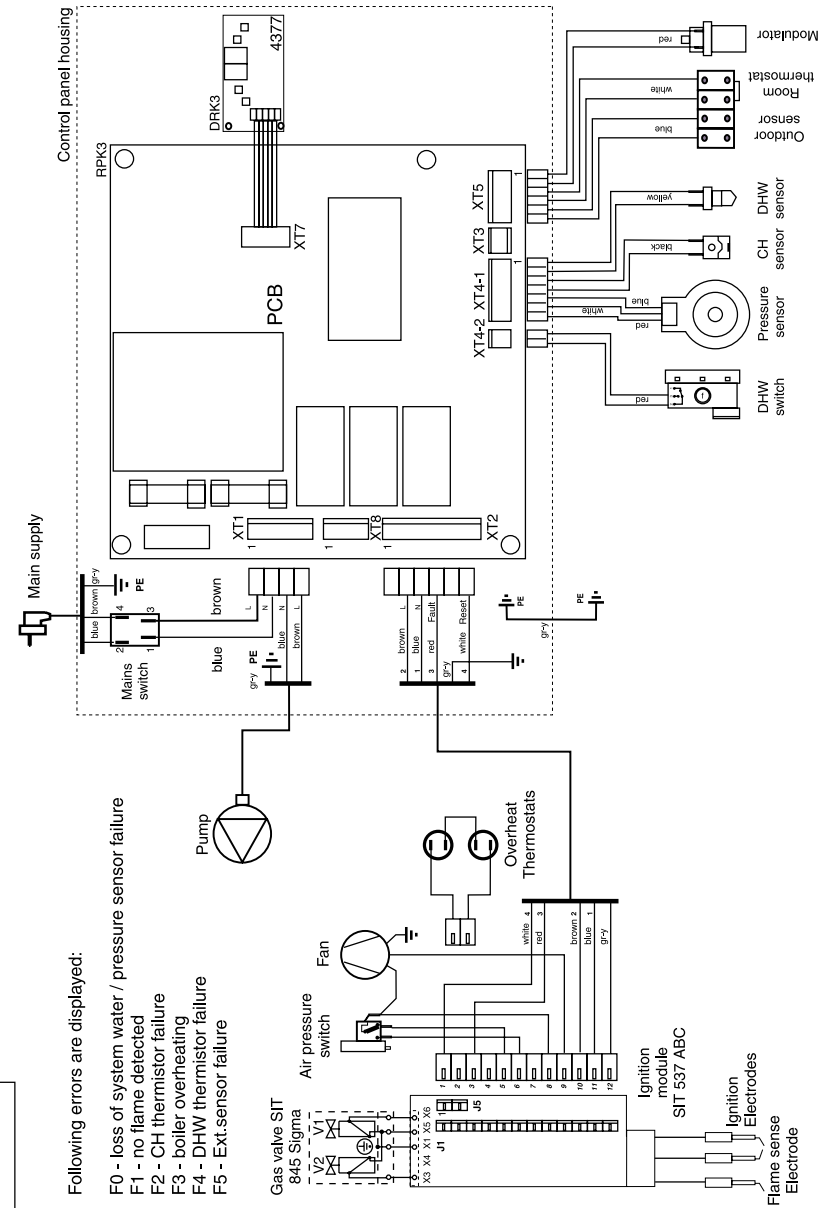

Diagram 22

- Fit replacement heat exchanger in reverse order to removal.
- Open isolating valves on flow and return connections, refill, vent and pressurise boiler. Check for leaks.

## SCHEMATIC WIRING DIAGRAM

Diagram 23



## FAULT FINDING

---

Before fault finding, make sure that:

- All gas cocks are open and there is an inlet gas pressure of 20 mbar (G 20)
- The heating system pressure is at least 1 bar.
- There is a permanent mains supply to the boiler
- The fuses on the PCB are intact.
- All external controls are correctly wired and calling for heat.

**WARNING:** Always isolate the boiler from the electrical supply before carrying out any electrical replacement work. Always check for gas soundness after any service work.

### Digital display shows:

- CH temperature (no decimal point displayed)
- DHW temperature (decimal point displayed)
- diagnostic error messages
- pressure in CH system
- boiler output setting

As soon as the mains switch is on the display shows for a very short time the version of software used. It has no importance for boiler operation.

### Diagnostic error messages

In the event of a fault the following diagnostic error messages will be displayed:

Message	Fault	Action	Comments
<b>F0</b>	Loss of system water	Refill system Check for leaks	Pump runs for one minute. Boiler is restarted by switching of main switch.
	Air lock in boiler Pressure sensor failure	Bleed boiler and system Check the pressure sensor (Sensing inlet must not be clogged)	
<b>F1</b>	No flame detected	Check flame sense electrode and connecting cable Check ignition electrode Check ignition unit on gas valve Check fan operation	
	Overheating of the boiler	Reset overheat thermostats Check the pump revolution	If overheat Thermostats are blocked, boiler does not ignite when starting

<b>F2</b>	Central heating thermistor failure	Check if flow thermistor is not disconnected or short-circuited Sensor Ohm resistance 10 kΩ by 25°C, 12,7 kΩ by 20°C, 16 kΩ by 15°C	
	CH water temperature below 3°C	Check if system is not frozen	
<b>F3</b>	Heat exchanger blockage	Check main heat exchanger Check domestic heat exchanger	Boiler shuts down and pump runs
<b>F4</b>	Domestic hot water thermistor faulty	Check thermistor/leads Sensor Ohm resistance: 10 kΩ by 25°C 12,7 kΩ by 20°C 16 kΩ by 15°C	Domestic hot water is available but poor
<b>F5</b>	A defect of the external sensor	Check the sensor's connection Check the sensor	The boiler provides heating with constant temperature of heating water as preset in the CHW mode

### Air pressure switch failure:

If the fan and the pump is running but the boiler doesn't light, check the air pressure switch.

### Blown fuses:

If the main switch is on and display does not light check the FUSE (1) T80mA, see diagram 21.

If the display lights but the pump, the fan and the ignition module don't work check the FUSE (2) T1.6A, see diagram 21.

### Warning message:

If the pressure in CH system drops to 0.8 bar the LED on the Bar/MODE button starts to flash. This give you information that CH pressure is on the low limit and must be pressurised. Nevertheless the boiler works until the pressure drops to 0.6 bar – then boiler shuts down and F0 is displayed.

### DHW flow is poor

If DHW flow is poor or boiler does not start when hot water tap is open, check following: Cold water supply pressure is at least 1 bar.

Check if the cold water filter or flow regulator (plastic 'O' ring) is not clogged.



## PROVITHERM 28 KTV – CONVERSION TO LPG

**Note:** Conversion must only be carried out by a competent person

- Isolate boiler from the gas and electrical supplies.
- Remove boiler casing, sealed chamber and combustion chamber cover as described in Installation/Service Instructions.
- Disconnect flame sense electrode.
- Disconnect ignition lead at gas valve module.
- Disconnect ignition earth lead.
- Undo nut securing gas supply pipe between burner and gas valve.
- Unscrew 2 screws securing burner to base of sealed chamber.
- Pull main burner up and forward out of boiler.

**Note:** The washer between the burner and burner gas supply must be kept to use in reassembly.

- Fit new burner with marked diameter of injector  $\varnothing$  **0.73** mm to the boiler in reverse order to removal.
- Readjust the gas valve.

### Gas Valve Adjustment

To adjust the minimum and maximum settings, proceed as follows:

- Unlock the PCB box and swing it down
- Connect a manometer to the burner pressure test point (**b**) on the gas valve
- Remove the modulator plastic cap protecting the adjusting screw on the top of modulating coil
- Start the boiler in Domestic Hot Water mode to reach max. capacity (hot water tap fully open)
- Adjust the gas valve maximum pressure Pmax using nut (**1**) on the top of modulating coil. Turn the nut (**1**) fully clockwise by means of spanner No. 10 to reach Pmax (check on the manometer)
- Adjust the gas valve maximum pressure Pmin using red plastic screw on the top of modulating coil.
- Disconnect the connector from the modulating coil to assure that boiler will operate on minimum. Block the nut (**1**) in the fully clockwise position by means of spanner and by means of screwdriver turn the red plastic screw (**2**). Turn clockwise to increase, anti-clockwise to decrease. Check Pmin on the manometer.
- Connect the connector to modulating coil and check again the Pmax to be sure that nut (**1**) didn't move.
- Re-place the plastic cap cover on the modulator and disconnect manometer
- Check for gas soundness
- Replace the PCB box and all covers
- Stick the self-adhesive label (delivered with LPG conversion kit) bearing the information about the gas type and the gas supply pressure on the visible place inside the boiler.

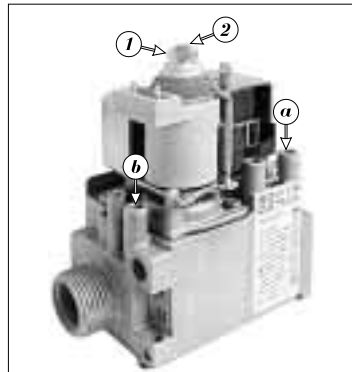

Provitherm 28 KTV	Inj. diam.	Pmin	Pmax
G20 (20 mbar)	1.20 mm	2.5 mbar	14.0 mbar
G30 (29 mbar)	0.73 mm	4.9 mbar	27.5 mbar
G31 (36 mbar)	0.73 mm	4.9 mbar	36.0 mbar

**NOTES:**

-----

-----

-----

-----

-----

-----

-----

-----

-----

-----

-----

-----

-----

-----

-----

-----

-----

-----

-----

-----

-----

-----

-----

-----