

# Service instructions

for heating engineers

# VIESSMANN

## Vitodens 300

Type **WB3A**, 49 and 66 kW

Gas fired wall mounted condensing boiler  
natural gas and LPG version

*See applicability on the last page*



## VITODENS 300



## Safety instructions



Please follow these safety instructions closely to prevent accidents and material losses.

### Safety instructions explained



#### **Danger**

This symbol warns against the risk of injury.



#### **Important information**

This symbol warns against the risk of material losses and environmental pollution.

#### **Note**

*Details identified by the words "Note" contain additional information.*

### Warranty

All warranty rights are void if these service instructions are not observed.

### Target group

These service instructions are exclusively designed for qualified personnel.

Work on gas equipment must only be carried out by a registered gas fitter. Only approved contractors may modify this equipment for countries other than those designated on the type plate. That contractor will then arrange for the relevant approval in that country.

Electrical work must only be carried out by a qualified electrician.

The system must be commissioned by the system installer or a qualified person authorised by the installer.

### Regulations

Observe the following during service work:

- all legal instructions regarding the prevention of accidents,
- the TRGI, TRF and special regulations, e.g. those of the BDH,
- all legal instructions regarding environmental protection,
- the Code of Practice by relevant trade associations and all local regulations.

### If you notice a smell of gas



#### **Danger**

Escaping gas can cause explosions which may lead to serious injury.

- Do not smoke. Prevent naked flames and sparks. Never switch electrical lights or equipment.
- Open windows and doors.
- Close the gas shut-off valve.
- Remove all personnel from the danger zone.
- Observe the safety regulations of your local gas supplier which can be found on the gas meter.
- Notify your heating contractor from outside the building.

## Safety instructions (cont.)

### If you smell flue gas



#### **Danger**

Flue gas may lead to life-threatening poisoning.

- Shut down the heating system.
- Ventilate the boiler room.
- Close all doors leading to the living space.

### Repair work

It is not permitted to carry out repairs on parts that fulfil a safety function. Use only original Viessmann spare parts, or equivalent parts that have been approved by Viessmann.

### Service work on the heating system

- Isolate the system from mains supply, e.g. by removing a separate fuse or by means of a mains electrical isolator, and check that it is no longer 'live'.
- Safeguard the system against unauthorised reconnection.
- When using gas as fuel, also close the main gas shut-off valve and safeguard against unauthorised reopening.

### Ancillary components, spare and wearing parts



#### **Important information**

Components which are not tested with the heating system, the installation of non-approved spare parts and unauthorised conversion may lead to damage to the heating system, which may affect their function and limit our warranty. For conversions or replacements, use only original parts from Viessmann or those which are approved by Viessmann.

**Index**

**Initial start-up, inspection, maintenance**  
 Steps - initial start-up, inspection and maintenance ..... 5  
 Further details regarding the individual steps ..... 7

**Coding**  
 Code 1 ..... 38  
 Code 2 ..... 42  
 Resetting the coding to the delivered condition ..... 62

**Service scans**  
 Service level summary ..... 63  
 Temperatures, boiler coding card and brief scans ..... 64  
 Checking outputs (relay test) ..... 68  
 Scanning operating conditions and sensors ..... 70

**Troubleshooting**  
 Calling up fault code history ..... 73  
 Call up current fault codes ..... 73  
 Checking and acknowledging faults ..... 75  
 Repairs ..... 85

**Function description**  
 Constant temperature control units ..... 95  
 Weather-compensated control units ..... 96  
 Extensions for external connections (accessory) ..... 98  
 Control functions ..... 102

**Designs**  
 Connection and wiring diagrams – internal connections ..... 107  
 Connection and wiring diagrams – external connections ..... 109

**Parts lists** ..... 111

**Commissioning/service reports** ..... 118

**Specification** ..... 124

**Certificates**  
 Declaration of conformity ..... 125  
 Manufacturer's certificate according to the 1st BImSchV [Germany] ..... 126

**Keyword index** ..... 127

**Steps - initial start-up, inspection and maintenance**

*For further instructions on individual steps, see pages indicated*

			Page
		Commissioning steps	
		Inspection steps	
		Maintenance steps	
•		<b>1. Filling the heating system</b> .....	7
•		<b>2. Venting the boiler</b> .....	8
•		<b>3. Venting the heating system</b> .....	8
•		<b>4. Filling the siphon with water</b> .....	9
•		<b>5. Checking the electrical mains connection</b>	
•		<b>6. Language selection (if required) - only for the weather-compensated control units</b> .....	9
•	•	<b>7. Setting the time and date (if required) - only for weather-compensated control units</b> .....	9
•		<b>8. Checking the gas type</b> .....	10
•		<b>9. Changing the gas type (see separate installation instructions)</b>	
•	•	<b>10. Function sequence and possible faults</b> .....	10
•	•	<b>11. Checking static and supply pressure</b> .....	12
•	•	<b>12. Checking the CO<sub>2</sub> settings</b> .....	14
•		<b>13. Setting the max. output</b> .....	16
•	•	<b>14. Checking all connections on the primary and DHW side for leaks</b>	
•	•	<b>15. Checking the burner (recording values on page 118 of commissioning report)</b>	
•		<b>16. Checking the balanced flue system for soundness (annular gap check)</b> .....	17
	•	<b>17. Removing the burner and checking the burner gasket (replace gasket every two years)</b> .....	18
	•	<b>18. Checking the burner gauze assembly</b> .....	19
	•	<b>19. Checking and adjusting the ignition and ionisation electrodes</b> .....	19



## Further details regarding the individual steps

### Filling the heating system

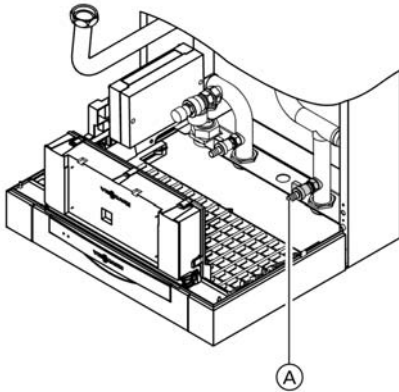

1. Check the charge pressure of the diaphragm expansion vessel.
2. Close the gas shut-off valve.

3. **!** **Important information**  
Unsuitable fill water increases the level of deposits and corrosion and may lead to boiler damage.
  - Thoroughly flush the entire heating system prior to filling with water.
  - Only use fill water of potable quality.
  - Soften fill water harder than 20 °dH (3.58 mmol/l). For suitable means of water softening, see the Vitotec pricelist.
  - An anti-freeze additive suitable for heating systems can be mixed with the fill water.

Fill the heating system via the boiler fill & drain valve (A) (minimum system pressure > 0.8 bar).

4. Close the boiler fill & drain valve (A).

## Further details regarding the individual steps (cont.)

### Venting the boiler

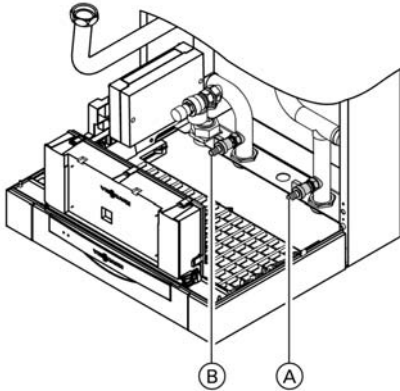

1. Close the shut-off valves on the heating water side.
2. Connect the drain hose to the boiler fill & drain valve (B).
3. Open valves (A) and (B), and vent at mains pressure, until no sound of escaping air can be heard.
4. Close valves (A) and (B), and open the primary shut-off valves.

### Venting the heating system

1. Close the gas shut-off valve and start the control unit.
2. Activate the venting program via coding address 2F:1.

**Note**

*To call up code 1 and for setting the coding address, see page 38.  
For function and sequence of the venting program, see page 103.*

3. Check the system pressure.



## Further details regarding the individual steps (cont.)

### Filling the siphon with water

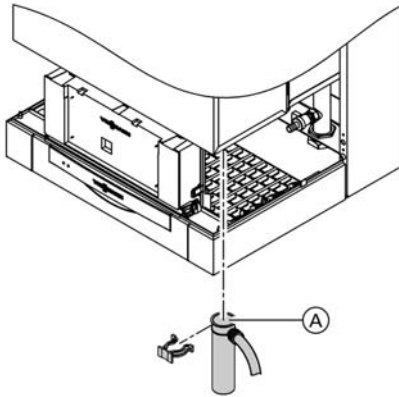

1. Remove the retaining clip and siphon (A).
2. Fill the siphon with water.
3. Fit siphon (A) and secure with the retaining clip.

### Language selection (if required) - only for the weather-compensated control units

1. Press (i).
2. Select the required language with (-).
3. Confirm with (OK).

### Setting the time and date (if required) - only for weather-compensated control units

#### Note

*During commissioning, or after prolonged time out of use, it may be necessary to set the time and date.*

1. Press (clock icon).
2. Set the correct time with (+)/(-).
3. Confirm with (OK); **Date** will then be displayed.
4. Set the current date with (+)/(-).
5. Confirm with (OK).

Initial start-up, inspection, maintenance

## Further details regarding the individual steps (cont.)

### Checking the gas type



#### Important information

The natural gas version **cannot** be converted to LPG.

1. Enquire about the gas type and Wobbe index (Wo) from your local mains gas or LPG supplier.

#### Note

*In the delivered condition, Vito-dens 300 is set up for natural gas E or LPG P.*

#### Natural gas E version:

*The boiler can be operated in the Wobbe index range 12.0 to 16.1 kWh/m<sup>3</sup> (43.2 to 58.0 MJ/m<sup>3</sup>).*

#### LPG P version:

*The boiler can be operated in the Wobbe index range 21.4 to 22.5 kWh/m<sup>3</sup> (76.9 to 81.0 MJ/m<sup>3</sup>).*

2. Compare the gas category (gas type) and gas group with the details on the label on the gas train and the cap plate.

3. If these details do not match the fuel provided, the burner must be converted according to the details provided by the mains gas or the LPG supplier.



See separate conversion kit installation instructions.

#### After conversion from

##### ■ Natural gas E or LPG P to natural gas LL

The boiler can be operated in the Wobbe index range 10.0 to 13.1 kWh/m<sup>3</sup> (36.0 to 47.2 MJ/m<sup>3</sup>).

##### ■ LPG P to natural gas E

The boiler can be operated in the Wobbe index range 12.0 to 16.1 kWh/m<sup>3</sup> (43.2 to 58.0 MJ/m<sup>3</sup>).

4. Set the gas type via coding address 1E at the control unit.

#### Note

*To call up code 1 and for setting the coding address, see page 38.*

5. Record the gas type in the service report on page 118.

### Function sequence and possible faults

For further details regarding faults, see page 75.

**Further details regarding the individual steps (cont.)**

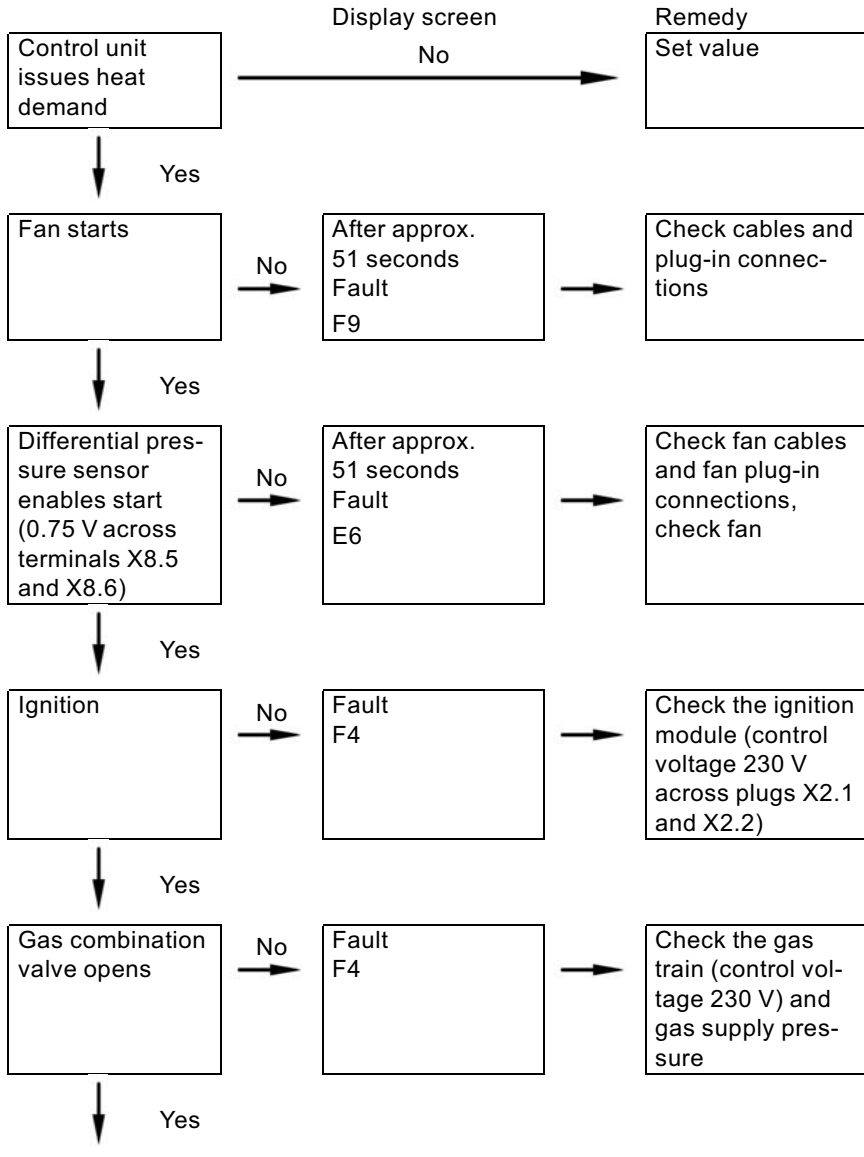

Initial start-up, inspection, maintenance

### Further details regarding the individual steps (cont.)

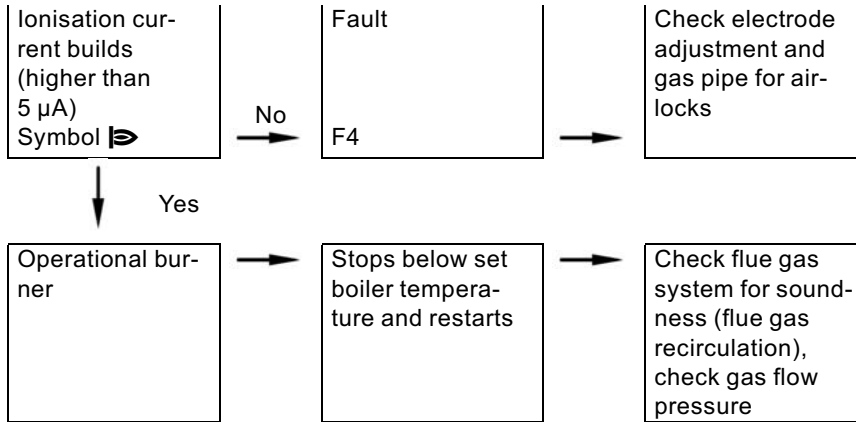

### Further details regarding the individual steps (cont.)

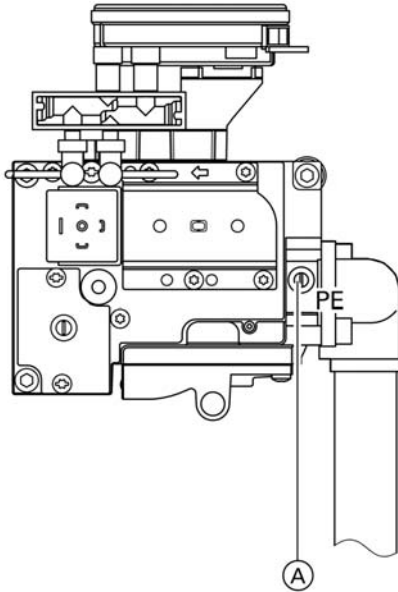

1. Close the gas shut-off valve.
2. Release the screw inside test nipple PE (A) on the gas combination valve, but do not remove, and connect the pressure gauge.
3. Open the gas shut-off valve.
4. Check the static pressure; it should be a max. of 57.5 mbar. Record the actual value in the service report.
5. Start up boiler.

**Note**

*During commissioning, the boiler can enter a fault state because of airlocks in the gas pipe. After approx. 5 seconds, press  to reset the burner.*

6. Check the supply (flow) pressure; it should be
  - 20 mbar for natural gas,
  - 50 mbar for LPG.

**Note**

*Use suitable test equipment with a resolution of at least 0.1 mbar to measure the supply pressure.*

Record the actual value in the service report.

Take the action shown in the table. 

Initial start-up, inspection, maintenance

### Further details regarding the individual steps (cont.)

Supply (flow) pressure for natural gas	Supply (flow) pressure for LPG	Remedy
Below 17.4 mbar	Below 42.5 mbar	Do not start up. Notify your mains gas or LPG supplier.
17.4 to 57.5 mbar	42.5 to 57.5 mbar	Start up boiler.
Above 57.5 mbar	Above 57.5 mbar	Install a separate gas governor downstream of the system and regulate the pressure to 20 mbar for natural gas or 50 mbar for LPG. Notify your mains gas or LPG supplier.

7. Shut down the boiler, close the gas shut-off valve, remove the pressure gauge, and close test nipple (A) with the screw.
8. Open the gas shut-off valve and start the boiler.



#### **Danger**

Gas escaping from the test nipple leads to a risk of explosion.  
Check test nipple (A) for soundness.

## Checking the CO<sub>2</sub> settings

Vitodens 300 is factory-set for natural gas E or LPG P. The natural gas E version can be converted to natural gas LL using a conversion kit. The LPG P version can be converted to natural gas E or LL using a conversion kit. During commissioning or maintenance, check the CO<sub>2</sub> level at the boiler adaptor.

#### **Note**

*The MatriX burner for Vitodens 300 is preset for the entire gas group. Therefore, the burner requires no further setting or adjustment.*

Subject to the Wobbe index, the CO<sub>2</sub> content fluctuates between

### Further details regarding the individual steps (cont.)

- 6.6 to 10.0 % for natural gas E
- 7.0 to 10.0 % for natural gas LL and
- approx. 10.0 % for LPG P.

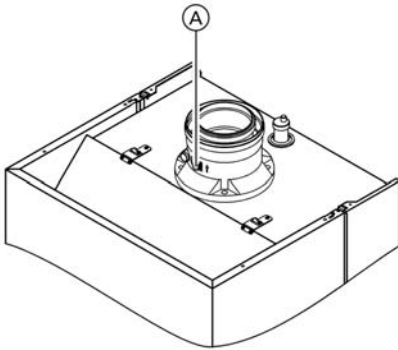

Compare the actual CO<sub>2</sub> value with the above CO<sub>2</sub> value ranges for the individual gas groups (check the gas group with your mains gas or LPG supplier). If the actual CO<sub>2</sub> value deviates by more than 1 % for natural gas or 0.5 % for LPG, proceed as follows:

- Check whether the correct gas restrictor has been installed.
- Check the balanced flue system for soundness, see page 17.





1. Connect a flue gas analyser at the flue gas aperture (A) on the boiler adaptor.
2. Open the gas shut-off valve, commission the boiler and create a heat demand.
3. Select the lower rated output.

Constant temperature control units:

- Press both keys  and  simultaneously, until the display shows 1.

Weather-compensated control units:

- Press both keys  and  simultaneously until the display shows "Relay test".
- With  in the display, select "Basic load".

4. Check the CO<sub>2</sub> content. Should the actual value deviate by more than 1 % from the above range, implement steps from page 15 (possibly replace the burner).
5. Enter actual values into the service report.



## Further details regarding the individual steps (cont.)

### 6. Set the upper rated output.

Constant temperature control units:

- With  $\oplus/\ominus$  in the display, select 2.

Weather-compensated control units:

- With  $\oplus/\ominus$  in the display, select "Full load".

### 7. Check the CO<sub>2</sub> content. Should the actual value deviate by more than 1 % from the above range, implement steps from page 15 (possibly replace the burner).

### 8. After testing, press $\textcircled{\text{OK}}$ .

### 9. Enter actual values into the service report.

## Setting the max. output

### Note

The max. output can be limited for **heating operation**. You can limit the output via the modulation range.

#### 1. Start up boiler.

2. Press both  $\text{⏻}$  and  $\text{⏮}$  simultaneously until 100 flashes on the display, (equals 100 % of the rated output) and  $\text{⏮}$  appears. On weather-compensated control units, the display additionally shows "Max. output".

3. With  $\oplus/\ominus$  select the required value in % of rated output as max. output.

#### 4. Confirm the set value with $\text{Ⓚ}$ .

5. Record the settings for max. output on the additional type plate included with the technical documentation. Affix the type plate next to the original type plate on top of the boiler.

### Note

The output can also be limited for **DHW loading**. For this, change coding address 6F in code 2.



### Further details regarding the individual steps (cont.)

## Checking the balanced flue system for soundness (annular gap check)

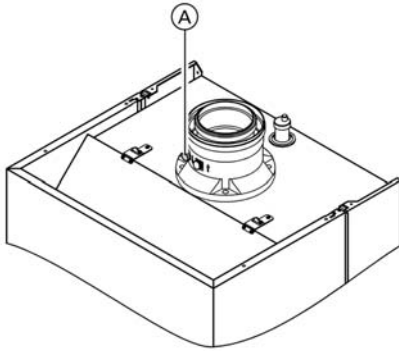

Ⓐ Combustion air aperture

For balanced flue systems tested together with the gas fired wall mounted boiler, some Federal States (e.g. Nordrhein-Westphalia) waive the requirement for a soundness test (overpressure test) during commissioning by the flue gas inspector. For such cases we recommend that your heating contractor carries out a simple soundness test during the initial start-up of your system. For this, it would be sufficient to check the CO<sub>2</sub> concentration in the combustion air at the annular gap in the balanced flue pipe.

The flue pipe is deemed to be sound, if the CO<sub>2</sub> concentration of the combustion air is no higher than 0.2 % or the O<sub>2</sub> concentration is at least 20.6 %.

If actual CO<sub>2</sub> values are higher or O<sub>2</sub> values are lower, carry out a pressure test on the flue pipe at a static pressure of 200 Pa.

## Further details regarding the individual steps (cont.)

### Removing the burner and checking the burner gasket (replace gasket every two years)

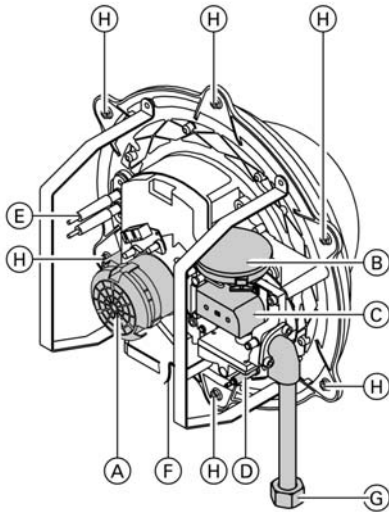

1. Switch OFF the control unit ON/OFF switch and the mains electrical supply.
2. Close the gas shut-off valve and safeguard against reopening.
3. Pull electrical cables from fan motor (A), differential pressure sensor (B), gas valve (C), ionisation electrode (D), ignition electrodes (E) and earth (F).
4. Release gas connection pipe (G) fixing screws and fittings.
5. Release six nuts (H) and remove the burner.



#### Important information

Prevent damage to the wire mesh.

Never rest the burner on the gauze assembly.

6. Check the burner gasket (see parts list) for damage. Generally, replace the burner gasket **every two years**.

## Further details regarding the individual steps (cont.)

### Checking the burner gauze assembly

Replace the burner gauze assembly if the wire mesh is damaged.

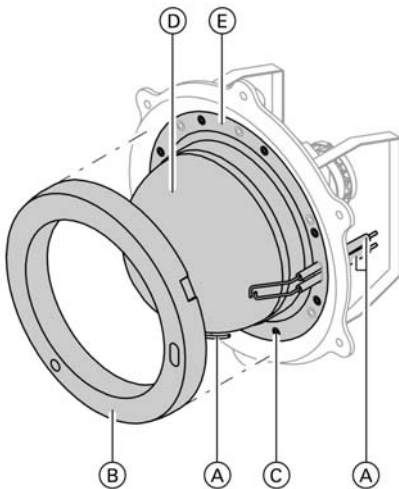

1. Remove electrodes (A).
2. Turn thermal insulation ring (B) clockwise and remove.
3. Release the eight Torx screws (C) and remove the burner gauze assembly (D).
4. Remove the old gauze assembly gasket (E).
5. Insert a new burner gauze assembly with a new gasket, and secure with eight Torx screws.

**Note**

*Torque: 4.5 Nm*

6. Refit the thermal insulation ring (B).

### Checking and adjusting the ignition and ionisation electrodes

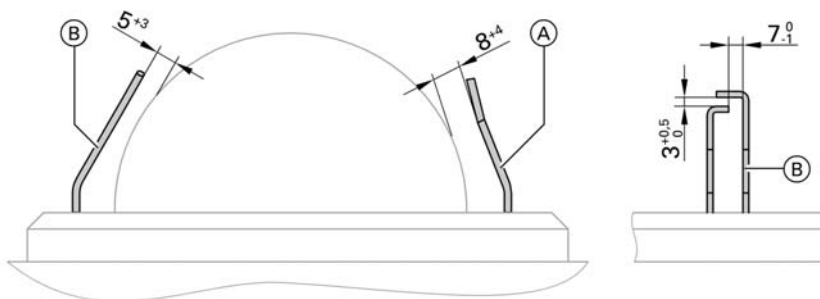

Initial start-up, inspection, maintenance

### Further details regarding the individual steps (cont.)

1. Check the electrodes for wear and contamination.
2. Clean the electrodes with a small brush (not with a wire brush) or emery paper.
3. Check all clearances. If the gaps are not as specified or the electrodes are damaged, replace and align the electrodes together with new gaskets. Tighten the electrode fixing screws with 2 Nm.

**!** **Important information**  
Wire mesh  
do not damage.

## Further details regarding the individual steps (cont.)

### Cleaning the combustion chamber/heating surfaces and installing the burner

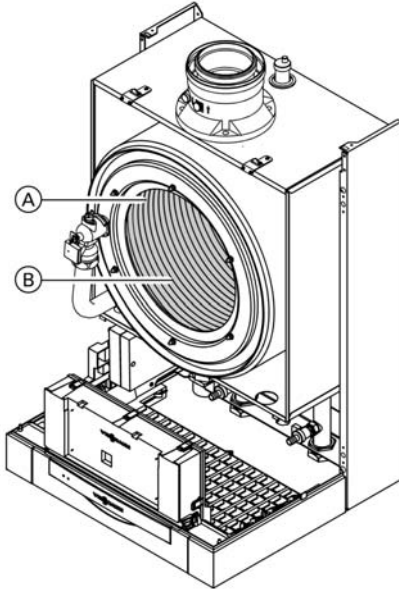

1. If required, clean combustion chamber (A) and heating surfaces (B) with a brush or flush with water.

**!** **Important information**  
Scratches on parts which are in contact with flue gases can lead to corrosion. Only use plastic brushes and NOT wire brushes.

Apply a solvent-/potassium-free cleaning agent if residues remain:

- Remove soot deposits with alkaline cleaning agents with additional surfactants (e.g. Fauch 600).
- Remove coatings and surface discolouration (yellow-brown) with slightly acidic, chloride-free cleaning agents based on phosphoric acid (e.g. Antox 75 E).
- Thoroughly flush with water.

#### **Note**

*Fauch 600 and Antox 75 E are supplied by:*

*Hebro Chemie GmbH  
Rostocker Straße 40*

*D 41199 Mönchengladbach*

*☎: Intec Bassersdorf AG  
Grindelstrasse 12*

*Postfach*

*CH-8303 Bassersdorf*

2. Install the burner and torque nuts diagonally with 4.5 Nm.



### Further details regarding the individual steps (cont.)

3. Secure the gas supply pipe with a new gasket.
4. Check the gas connections for soundness.



**Danger**

Escaping gas leads to a risk of explosion.  
Check all fittings for soundness.

5. Connect the electrical cables/leads to each corresponding component.

### Checking the condensate drain and cleaning the siphon

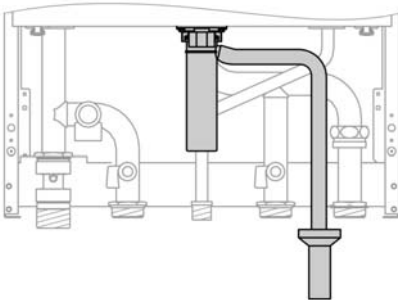

1. Check at the siphon, that the condensate can freely drain.
2. Remove the retaining clip and the siphon.
3. Clean the siphon.
4. Fit the siphon and secure with the retaining clip.

### Checking all gas equipment for soundness at operating pressure



**Danger**

Escaping gas leads to a risk of explosion.  
Check gas equipment for soundness.

## Further details regarding the individual steps (cont.)

### Checking the ionisation current

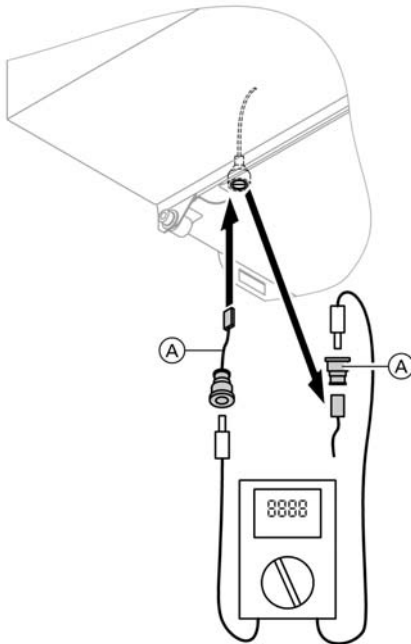

- (A) Adaptor line (available as accessory)  
(B) Control unit cable

1. Remove the cable and connect the test equipment.
2. Set the upper rated output.

Constant temperature control units:

- Press  $\phi$  and  $\text{OK}$  simultaneously for at least 2 seconds.
- With  $\oplus/\ominus$  in the display, select 2.

Weather-compensated control units:

- Press  $\phi$  and  $\text{OK}$  simultaneously for at least 2 seconds.
- With  $\oplus/\ominus$  in the display, select "Full load".

#### Note

*The minimum ionisation current should be at least  $5 \mu\text{A}$  as soon as the flame is established (approx. 2 - 3 seconds after opening the gas train).*

3. If the ionisation current is  $< 5 \mu\text{A}$ ;
  - Check the electrode gap, see page 19.
  - Check the control unit power supply.
4. After testing, press  $\text{OK}$ .
5. Record the actual value in the service report.

Initial start-up, inspection, maintenance

## Further details regarding the individual steps (cont.)

### Matching the control unit to the heating system

#### Note

The control unit must be matched to the system equipment. Various system components are automatically recognised by the control unit, and codes are automatically set.

- For selection of an appropriate design, see the following diagrams.
- For coding steps, see page 38.

#### System design 1

##### With/without DHW heating with 1 heating circuit without mixer

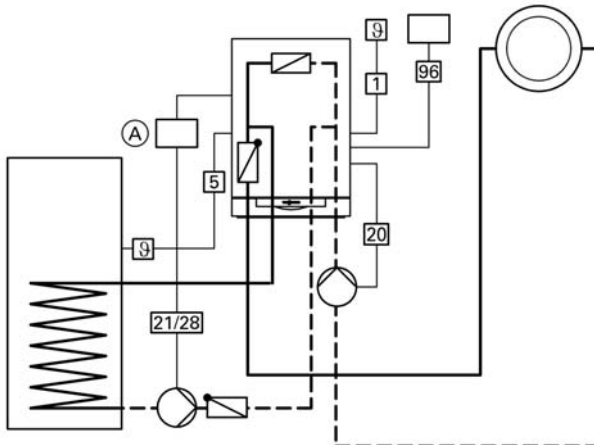

- |   |  |
|---|--|
| <p>1 Outside temperature sensor (only for weather-compensated control units)<br/>or</p> | <p>21 Cylinder loading pump (connection via external extension H1)</p>       |
| <p>96 Vitotrol 100 (only for constant temperature control units)</p>                    | <p>28 Cylinder loading pump (connection via internal extension H1 or H2)</p> |
| <p>5 Cylinder temperature sensor</p>  | <p>A Internal extension H1 or H2<br/>or<br/>External extension H1</p>        |
| <p>20 Heating circuit pump</p>  |  |



**Further details regarding the individual steps (cont.)**

Required coding	Address
Function relay of the internal extension: Cylinder loading pump	53:3

**System design 2**

**With/without DHW heating with 1 heating circuit with mixer and system separation**

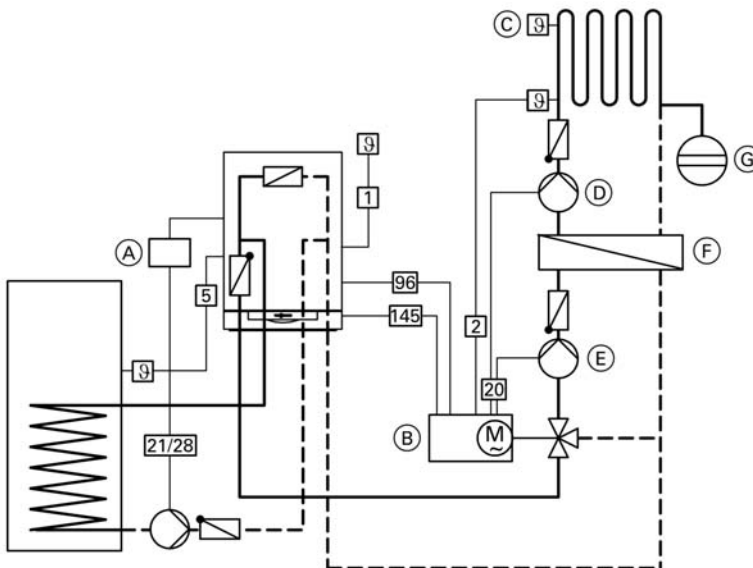

- |            |  |            |  |
|------------|--|------------|--|
| <b>1</b>   | Outside temperature sensor   | <b>(A)</b> | Internal extension H1 or H2 or External extension H1 |
| <b>2</b>   | Flow temperature sensor  | <b>(B)</b> | Extension kit for 1 heating circuit with mixer       |
| <b>5</b>   | Cylinder temperature sensor  | <b>(C)</b> | Maximum temperature controller (underfloor heating)  |
| <b>20</b>  | Heating circuit pump   | <b>(D)</b> | Heating circuit pump (secondary)                     |
| <b>21</b>  | Cylinder loading pump (connection via external extension H1)       | <b>(E)</b> | Heating circuit pump (primary)                       |
| <b>28</b>  | Cylinder loading pump (connection via internal extension H1 or H2) | <b>(F)</b> | Heat exchanger for system separation                 |
| <b>96</b>  | Power supply   | <b>(G)</b> | Expansion vessel                                     |
| <b>145</b> | KM BUS   |            |  |

Initial start-up, inspection, maintenance

### Further details regarding the individual steps (cont.)

Required coding	Address
1 heating circuit with mixer	
■ with DHW cylinder	00:4
■ without DHW cylinder	00:3
Function relay of the internal extension: Cylinder loading pump	53:3

### System design 3

With/without DHW heating with low loss header, 1 heating circuit without mixer and 1 heating circuit with mixer

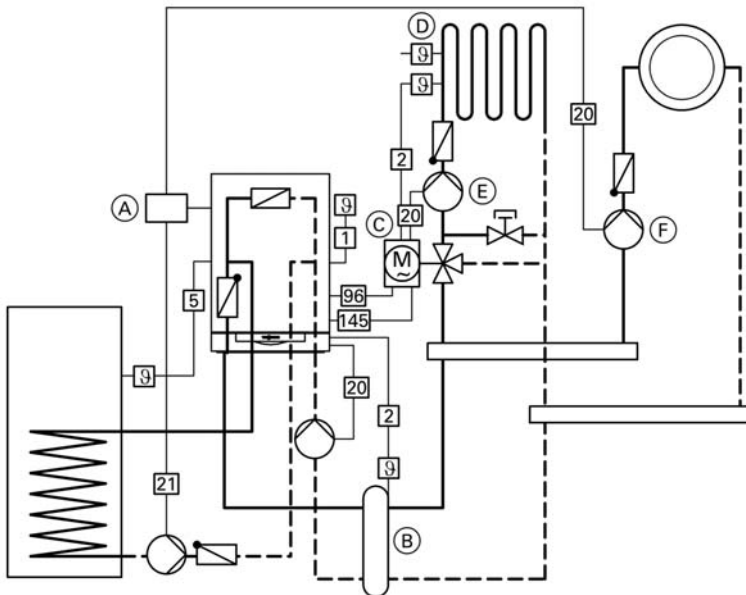

- |     |  |     |   |
|-----|--|-----|---|
| 1   | Outside temperature sensor                                   | (A) | External extension H1                               |
| 2   | Flow temperature sensor                                      | (B) | Low loss header                                     |
| 5   | Cylinder temperature sensor                                  | (C) | Extension kit for 1 heating circuit with mixer      |
| 20  | Heating circuit pump or boiler circuit pump                  | (D) | Maximum temperature controller (underfloor heating) |
| 21  | Cylinder loading pump (connection via external extension H1) |     |   |
| 96  | Power supply   |     |   |
| 145 | KM BUS   |     |   |

**Further details regarding the individual steps (cont.)**

- Ⓔ Heating circuit pump heating circuit with mixer
- Ⓕ Heating circuit pump heating circuit without mixer (connection via external extension H1)

Required coding	Address
—	—

Initial start-up, inspection, maintenance

## Further details regarding the individual steps (cont.)

### System design 4

With/without DHW heating with 3 or more heating circuits with mixer and low loss header

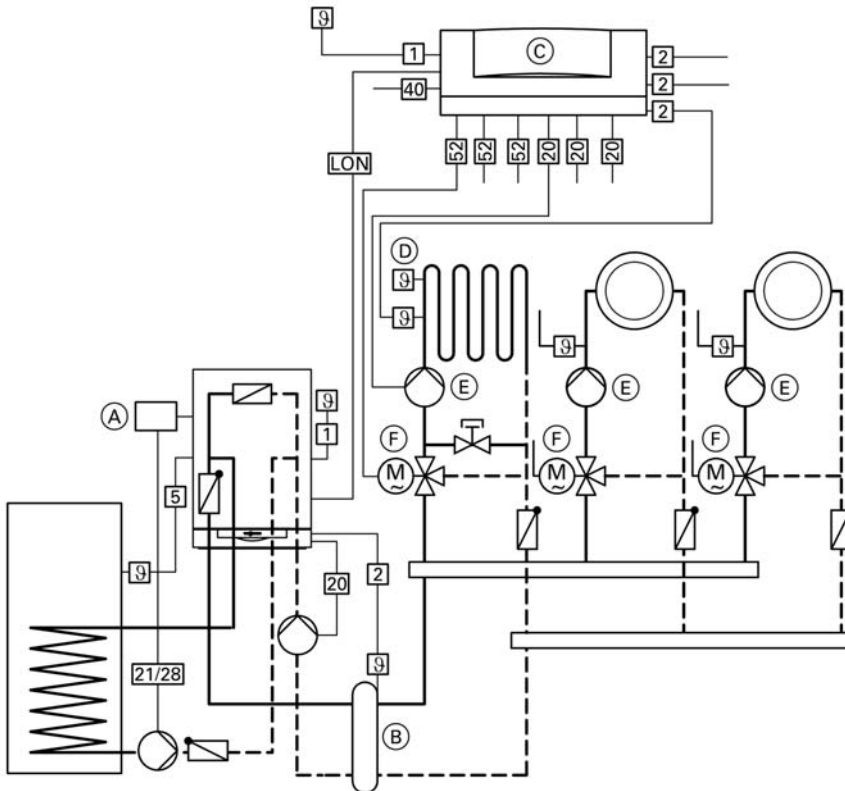

- |    |  |    |  |
|----|--|----|--|
| 1  | Outside temperature sensor                                   | 28 | Cylinder loading pump (connection via internal extension H1 or H2) |
| 2  | Flow temperature sensor                                      | 40 | Power supply   |
| 5  | Cylinder temperature sensor                                  | 52 | Mixer motor  |
| 20 | Heating circuit pump or boiler circuit pump                  | A  | Internal extension H1 or H2 or External extension H1               |
| 21 | Cylinder loading pump (connection via external extension H1) | B  | Low loss header  |

Initial start-up, inspection, maintenance

**Further details regarding the individual steps** (cont.)

- Ⓒ Vitotronic 050
- Ⓓ Maximum temperature controller (underfloor heating)
- Ⓔ Heating circuit pump
- Ⓕ Mixer motor

Required coding	Address
Function relay of the internal extension: Cylinder loading pump	53:3

Initial start-up, inspection, maintenance

## Further details regarding the individual steps (cont.)

### System design 5

**Multi-boiler system with/without DHW heating with several heating circuits with mixer and low loss header**

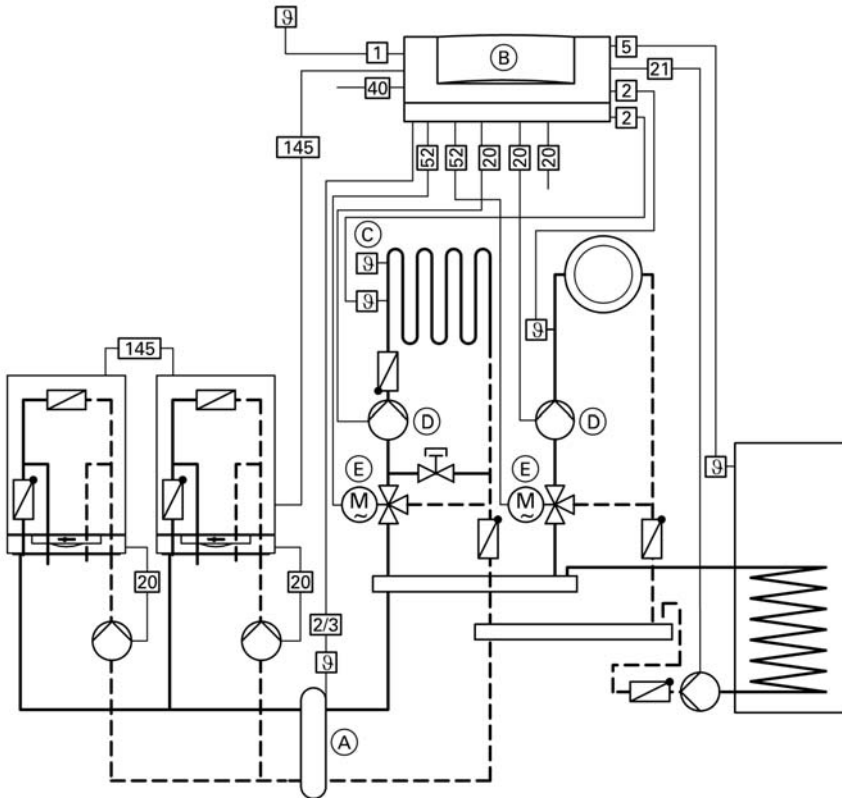

- |     |   |     |  |
|-----|---|-----|--|
| 1   | Outside temperature sensor                  | 40  | Power supply   |
| 2   | Flow temperature sensor heating circuits    | 52  | Mixer motor  |
| 2/3 | Flow temperature sensor / low loss header   | 145 | KM BUS   |
| 5   | Cylinder temperature sensor                 | A   | Low loss header  |
| 20  | Heating circuit pump or boiler circuit pump | B   | Vitotronic 333   |
| 21  | Cylinder loading pump                       | C   | Maximum temperature controller (underfloor heating system) |
|     |   | D   | Heating circuit pump                                       |
|     |   | E   | Mixer motor  |

**Further details regarding the individual steps (cont.)**

Required coding	Address
Multi-boiler system with Vitotronic 333	01:2

**Note**

Codes for multi-boiler system, see Vitotronic 333 installation and operating instructions.

**Connecting the control unit to the LON system (only for weather-compensated control units)**

The LON communication module (accessory) must be plugged in.

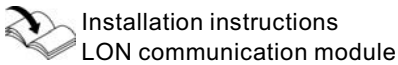

**Note**

Data transfer via the LON system can take 2 to 3 minutes.

**Setting up LON user numbers**

Adjust the user number via coding address 77 (see below).

In a LON system, the same number **cannot** be allocated twice.

**Updating the LON user list**

Only possible, if all users are connected, and the control unit is encoded as fault manager (code 79:1).

1. Press and simultaneously for approx. 2 seconds. User check initiated (see page 32).
2. Press . The user list is updated after approx. 2 minutes. User check completed.

**Single boiler system with Vitotronic 050 and Vitocom 300**

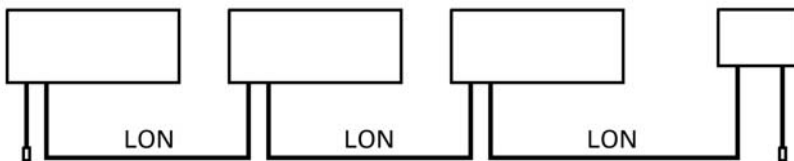

Initial start-up, inspection, maintenance

### Further details regarding the individual steps (cont.)

Boiler control unit	Vitotronic 050	Vitotronic 050	Vitocom
User no. 1 Code 77:1	User no. 10 Code 77:10	User no. 11 Set code 77:11	User no. 99
Control unit is fault manager*1 Code 79:1	Control unit is not fault manager*1 Code 79:0	Control unit is not fault manager*1 Code 79:0	Control unit is fault manager
Sent time via LON Code 7b:1	Time received via LON Set code 81:3	Time received via LON Set code 81:3	Time received via LON
Transmit outside temperature via LON Set code 97:2	Outside temperature is received via LON Set code 97:1	Outside temperature is received via LON Set code 97:1	—
Fault monitoring LON user code 9C:20	Fault monitoring LON user code 9C:20	Fault monitoring LON user code 9C:20	—

### Implementing a user check (in conjunction with the LON system)

Communication with the system devices connected to the fault manager is tested with a user check.

Preconditions:

- The control unit must be encoded as fault manager (code 79:1).
- The LON user number must be encoded in all control units (see page 31).
- The fault manager user list must be up to date (see page 31).

\*1 In each heating system, **only one Vitotronic** may be encoded as fault manager.



## Further details regarding the individual steps (cont.)

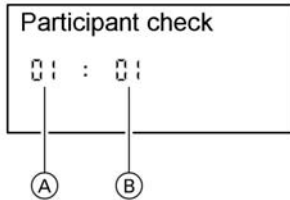

- (A) Consecutive list number
- (B) User number

1. Press and simultaneously for approx. 2 seconds. User check initiated.
2. Select the required user with and .
3. Activate checking with .
  - "Check" flashes until its completion. The display and all key illuminations of the selected user flash for approx. 60 seconds.
    - "Check OK" flashes during communication between both devices.
    - "Check not OK" flashes if there is no communication between both devices. Check LON connection.
4. For checking further users, proceed as for items 2 and 3.
5. Press and simultaneously for approx. 1 second. User check completed.

## Adjusting heating curves (only for weather-compensated control units)

The heating curves illustrate the relationship between the outside temperature and the boiler water or the flow temperature. To put it simply: the lower the outside temperature, the higher the boiler water or flow temperature. The room temperature, again, depends on the boiler water or the flow temperature.

Settings in the delivered condition:

- Slope = 1.4
- Level = 0

Generally, the slope of the heating curve lies

- in the range of (A) for underfloor heating systems,
- in the range of (B) for low temperature heating systems (according to the Energy Savings Order [Germany]).

**Further details regarding the individual steps (cont.)**

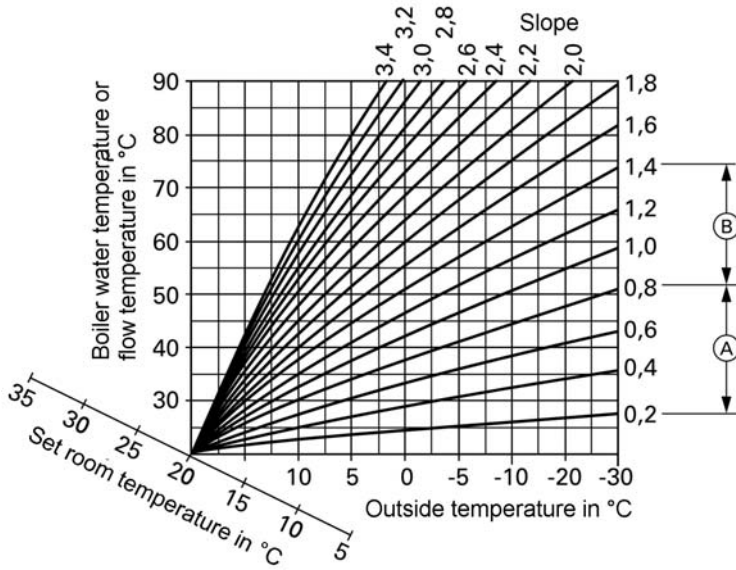

**Changing slope and level**

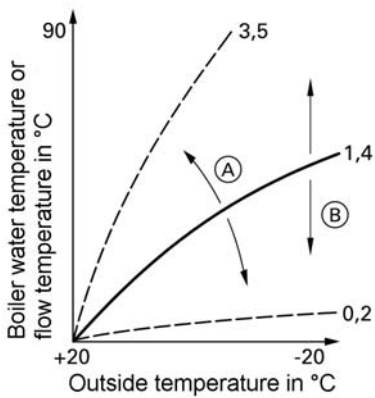

1. Modify the slope in code 1 with coding address d3 (see page 38). Value adjustable from 0.2 to 3.5.
2. Modify the slope in code 1 with coding address d4 (see page 38). Value adjustable from -13 to +40 K.

- Ⓐ Changing the slope
- Ⓑ Changing the level

## Further details regarding the individual steps (cont.)

### Adjusting the set room temperature

#### Standard room temperature:

1. Select a heating circuit:
  - Press  $\oplus$ .
  - 1  $\blacksquare$  flashes on the display.
  - Select heating circuit A1 (heating circuit without mixer):  
Press  $\text{OK}$ .
  - Select heating circuit M2 (heating circuit with mixer):
    - Press  $\oplus$ .
    - 2  $\blacksquare$  flashes on the display.
    - Press  $\text{OK}$ .

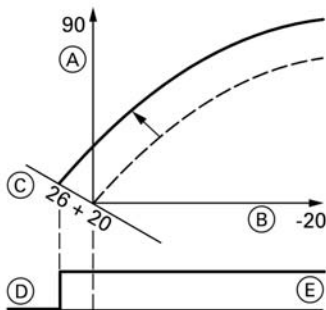



2. Adjust the set day temperature with rotary selector  $\downarrow$   $\star$ .  
The value will be automatically adopted after approx. 2 seconds. Accordingly, the heating curve is adjusted along the set room temperature axis, which results in modified start/shutdown characteristics of the heating circuit pumps, if the heating circuit pump logic is activated.

Example 1: Modifying the standard room temperature from 20 °C to 26 °C

- (A) Boiler water or flow temperature in °C
- (B) Outside temperature in °C
- (C) Set room temperature in °C
- (D) Heating circuit pump OFF
- (E) Heating circuit pump ON

## Further details regarding the individual steps (cont.)

### Reduced room temperature:

1. Select a heating circuit:
  - Press  $\oplus$ .
  - 1  flashes on the display.
  - Select heating circuit A1 (heating circuit without mixer):  
Press  $\text{OK}$ .
  - Select heating circuit M2 (heating circuit with mixer):
    - Press  $\oplus$ .
    - 2  flashes on the display.
    - Press  $\text{OK}$ .
2. Call up the set night temperature with .
3. Change this value with  $\oplus$  and  $\ominus$ .
4. Confirm the set value with  $\text{OK}$ .

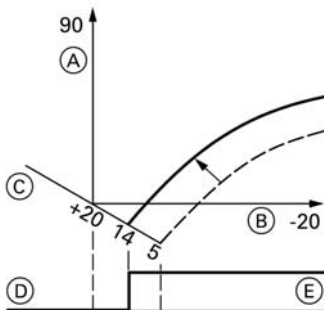

Example 2: Modifying the reduced room temperature from 5 °C to 14 °C.

- (A) Boiler water or flow temperature in °C
- (B) Outside temperature in °C
- (C) Set room temperature in °C
- (D) Heating circuit pump OFF
- (E) Heating circuit pump ON

### Instructing the system user

The system installer must hand the operating instructions to the system user and instruct them in the operation of the system.

## Further details regarding the individual steps (cont.)





### Scanning and resetting the "Maintenance" display

The red fault indicator flashes when the limits set via coding address 21 and 23 have been reached. As regards the operating interface display:

- For constant temperature control units, the hours run (subject to setting) or the given time interval and the clock symbol flashes.
- For weather-compensated control units "Maintenance" flashes.

#### Note

*Set code 24:1 and then code 24:0, if maintenance is implemented before maintenance is displayed; the set maintenance parameters for hours run and interval are then reset to 0.*

1. Press .  
Maintenance scan is activated.
2. Scan maintenance messages with  or .
3. Press , for weather-compensated control units also confirm the display "Acknowledge: Yes" with .  
"Maintenance" is cancelled from the display and the red fault indicator continues to flash.

#### Note



*An acknowledged maintenance message can be redisplayed by pressing  (approx. 3 seconds).*

#### After maintenance has been carried out

1. Reset code 24:1 to 24:0.  
The red fault indicator is extinguished.













#### Note

*If coding address 24 is not reset, a new "Maintenance" message will be displayed on Monday at 07:00 h.*

2. If required:
  - Press .
  - Reset burner hours run, burner starts and consumption (see page 70).
  - Press .

## Code 1

### Call up code 1

1. Press  and  simultaneously for approx. 2 seconds.
2. Select the required coding address with  or ; the address flashes. Confirm with ; the value flashes.
3. Change this value with  and ; confirm with . The display briefly shows "adopted", then the address flashes again. Select additional addresses (if required) with  or .
4. Press  and  simultaneously for approx. 1 second.

**Note**

*Codes are displayed in plain text on weather-compensated control units. Codes, which are not relevant because of the equipment level of your heating system or because of settings of other codes, will not be displayed.*

**Code 1** (cont.)**Summary****Codes**

<b>Coding in the as delivered condition Address: value</b>	<b>Function mode</b>	<b>Coding change Address: value</b>	<b>Possible change</b>
<b>System design</b>			
00:1	System version 1: 1 heating circuit without mixer A1, without DHW heating	00:2	System version 1: 1 heating circuit without mixer A1, with DHW heating
		00:3	System version 2, 4, 5: 1 mixer circuit M2, without DHW heating
		00:4	System version 2, 4, 5: 1 mixer circuit M2, with DHW heating
		00:5	System version 3: 1 heating circuit without mixer A1 and 1 mixer circuit M2, without DHW heating
		00:6	System version 3: 1 heating circuit without mixer A1, 1 mixer circuit M2 with DHW heating
<b>Single and multi-boiler system</b>			
01:1	*1Single boiler system	01:2	Multi-boiler system with Vitotronic 333
<b>Max. boiler temp.</b>			
06:...	Maximum limit of the boiler water temperature, defaulted by the boiler coding card	06:20 to 06:127	Maximum limit of the boiler water temperature within the ranges defaulted by the boiler

## Coding

**Code 1** (cont.)

<b>Coding in the as delivered condition Address: value</b>	<b>Function mode</b>	<b>Coding change Address: value</b>	<b>Possible change</b>
<b>Gas type</b>			
1E:0	Natural gas operation, defaulted by the boiler coding card	1E:1	LPG operation, defaulted by the boiler coding card
<b>Venting/filling</b>			
2F:0	Venting program disabled	2F:1	Venting program enabled
		2F:2	Filling program enabled
<b>User no.</b>			
77:1	LON user number	77:2 to 77:99	LON user number, adjustable from 1 to 99: 1 - 4 = boiler 5 = cascade 10 - ... = Vitotronic 050 99 = Vitocom  <b>Note</b> <i>Allocate each number only once.</i>
<b>DHW priority A1</b>			
A2:2	DHW cylinder priority applicable to heating circuit pump and mixer	A2:0	Without cylinder priority for heating circuit pump
<b>DHW priority M2</b>			
A2:2	DHW cylinder priority applicable to heating circuit pump and mixer	A2:0	Without DHW cylinder priority applicable to heating circuit pump and mixer
		A2:1	DHW cylinder priority only applicable to mixer
		A2:3 to A2:15	Modulating DHW cylinder priority
<b>Summer econ. A1</b>			
A5:5	*1With heating circuit pump logic function	A5:0	Without heating circuit pump logic function

\*1Only for weather-compensated control units.















**Code 1** (cont.)



<b>Coding in the as delivered condition Address: value</b>	<b>Function mode</b>	<b>Coding change Address: value</b>	<b>Possible change</b>
<b>Summer econ. M2</b>			
A5:5	*1With heating circuit pump logic function	A5:0	Without heating circuit pump logic function
<b>Min. flow temp. A1</b>			
C5:20	Electronic limit of the minimum flow temperature: 20 °C	C5:1 to C5:127	Minimum limit adjustable from 1 to 127 °C
<b>Min. flow temp. M2</b>			
C5:20	Electronic limit of the minimum flow temperature: 20 °C	C5:1 to C5:127	Minimum limit adjustable from 1 to 127 °C
<b>Max. flow temp. A1</b>			
C6:75	*1Electronic maximum flow temperature limit at 75 °C	C6:1 to C6:127	Maximum limit adjustable from 1 to 127 °C
<b>Max. flow temp. M2</b>			
C6:75	*1Electronic maximum flow temperature limit at 75 °C	C6:1 to C6:127	Maximum limit adjustable from 1 to 127 °C
<b>Slope A1</b>			
d3:14	*1Heating curve slope = 1.4	d3:2 to d3:35	Heating curve slope adjustable from 0.2 to 3.5 (see page 33)
<b>Slope M2</b>			
d3:14	*1Heating curve slope = 1.4	d3:2 to d3:35	Heating curve slope adjustable from 0.2 to 3.3 (see page 33)
<b>Level A1</b>			
d4:0	*1Heating curve level = 0	d4:-13 to d4:40	Heating curve level adjustable from -13 to 40 (see page 33)
<b>Level M2</b>			
d4:0	*1Heating curve level = 0	d4:-13 to d4:40	Heating curve level adjustable from -13 to 40 (see page 33)

## Code 2

### Calling up code 2

1. Press  and  simultaneously for approx. 2 seconds; confirm with .
2. Select the required coding address with  or ; the address flashes. Confirm with ; the value flashes.
3. Change this value with  and ; confirm with . The display briefly shows "adopted", then the address flashes again. Select additional addresses (if required) with  or .
4. Press  and  simultaneously for approx. 1 second.

### Overall summary

The coding addresses are grouped in accordance with the following **function ranges**. The respective function range is displayed. Scroll through the ranges in the following sequence with  or .

Function range	Coding addresses
System design	00 and 01
Boiler/burner	06 to 54
DHW	56 to 73
General	76 to 9F
Boiler circuit (heating circuit A1 without mixer)	A0 to F7
Mixer circuit (heating circuit M2 with mixer)	A0 to F7

#### Note

*Codes, which are not relevant because of the equipment level of your heating system or because of settings of other codes, will not be displayed. For heating systems with 1 heating circuit without mixer and 1 heating circuit with mixer, initially the possible coding addresses A0 to F7 are scrolled for the heating circuit without mixer A1, then those for the heating circuit with mixer M2.*

**Code 2** (cont.)**Codes**

<b>Coding in the as delivered condition Address: value</b>	<b>Function mode</b>	<b>Coding change Address: value</b>	<b>Possible change</b>
<b>System design</b>			
00:1	System design 1: 1 heating circuit without mixer A1, without DHW heating	00:2	System design 1: 1 heating circuit without mixer A1, with DHW heating
		00:3	System design 2, 4, 5: 1 mixer circuit M2, without DHW heating
		00:4	System design 2, 4, 5: 1 mixer circuit M2, with DHW heating
		00:5	System design 3: 1 heating circuit without mixer A1 and 1 mixer circuit M2, without DHW heating
		00:6	System design 3: 1 heating circuit without mixer A1, 1 mixer circuit M2 with DHW heating
01:1	*1Single boiler system	01:2	Multi-boiler system with Vitotronic 333
<b>Boiler/burner</b>			
06:...	Maximum limit of the boiler water temperature, defaulted by the boiler coding card	06:20 to 06:127	Maximum limit of the boiler water temperature within the ranges defaulted by the boiler
07:1	*1Boiler number in multi-boiler systems	07:2 to 07:4	Boiler number 2 to 4 in multi-boiler systems
1E:0	Natural gas operation, defaulted by the boiler coding card	1E:1	LPG operation, defaulted by the boiler coding card

**Code 2** (cont.)

<b>Coding in the as delivered condition Address: value</b>	<b>Function mode</b>	<b>Coding change Address: value</b>	<b>Possible change</b>
21:0	No maintenance indication Burner	21:1 to 21:100	The number of hours run before the burner should be serviced is adjustable from 100 to 10000 hours (each step represents 100 hours)
23:0	No time interval for burner maintenance	23:1 to 23:24	Time interval adjustable from 1 to 24 months
24:0	No "Maintenance" display	24:1	"Maintenance" display (the address is automatically set and must be manually reset after maintenance has been completed)
25:0	*1No recognition of outside temperature sensor or remote monitoring	25:1	Recognition of outside temperature sensor and fault monitoring
28:0	No burner interval ignition	28:1	The burner is forced ON once every 24 hours
2E:0	Without external extension	2E:1	Including external extension (automatic adjustment on connection)
2F:0	Venting program disabled	2F:1	Venting program enabled
		2F:2	Filling program enabled
30:1	Internal variable speed circulation pump (automatic adjustment)	30:0	Internal circulation pump without variable speed (e.g. temporarily for service)
31:65	Set speed of the internal circulation pump when operated as boiler circuit pump 65 %, defaulted by the boiler coding card	31:0 to 31:100	Set speed adjustable from 0 to 100 %

\*1Only for constant temperature control units.

**Code 2** (cont.)

<b>Coding in the as delivered condition Address: value</b>	<b>Function mode</b>	<b>Coding change Address: value</b>	<b>Possible change</b>
32:0	Signal "External lock-out" on circulation pumps: All pumps are controlled	32:1 to 32:15	Signal "External lockout" on circulation pumps: See the following table

<b>Coding</b>	<b>Internal circulation pump</b>	<b>Heating circuit pump Heating circuit without mixer</b>	<b>Heating circuit pump Heating circuit with mixer</b>	<b>Cylinder loading pump</b>
0	Control funct.	Control funct.	Control funct.	Control funct.
1	Control funct.	Control funct.	Control funct.	OFF
2	Control funct.	Control funct.	OFF	Control funct.
3	Control funct.	Control funct.	OFF	OFF
4	Control funct.	OFF	Control funct.	Control funct.
5	Control funct.	OFF	Control funct.	OFF
6	Control funct.	OFF	OFF	Control funct.
7	Control funct.	OFF	OFF	OFF
8	OFF	Control funct.	Control funct.	Control funct.
9	OFF	Control funct.	Control funct.	OFF
10	OFF	Control funct.	OFF	Control funct.
11	OFF	Control funct.	OFF	OFF
12	OFF	OFF	Control funct.	Control funct.
13	OFF	OFF	Control funct.	OFF
14	OFF	OFF	OFF	Control funct.
15	OFF	OFF	OFF	OFF

Coding

**Code 2** (cont.)

<b>Coding in the as delivered condition Address: value</b>	<b>Function mode</b>	<b>Coding change Address: value</b>	<b>Possible change</b>
<b>Boiler/burner</b>			
34:0	Signal "External demand" on circulation pumps: All pumps are controlled	34:1 to 34:23	Signal "External demand" on circulation pumps: See the following table

<b>Coding</b>	<b>Internal circulation pump</b>	<b>Heating circuit pump Heating circuit without mixer</b>	<b>Heating circuit pump Heating circuit with mixer</b>	<b>Cylinder loading pump</b>
0	Control funct.	Control funct.	Control funct.	Control funct.
1	Control funct.	Control funct.	Control funct.	OFF
2	Control funct.	Control funct.	OFF	Control funct.
3	Control funct.	Control funct.	OFF	OFF
4	Control funct.	OFF	Control funct.	Control funct.
5	Control funct.	OFF	Control funct.	OFF
6	Control funct.	OFF	OFF	Control funct.
7	Control funct.	OFF	OFF	OFF
8	OFF	Control funct.	Control funct.	Control funct.
9	OFF	Control funct.	Control funct.	OFF
10	OFF	Control funct.	OFF	Control funct.
11	OFF	Control funct.	OFF	OFF
12	OFF	OFF	Control funct.	Control funct.

5692 550 GB



**Code 2** (cont.)

<b>Coding</b>	<b>Internal circulation pump</b>	<b>Heating circuit pump Heating circuit without mixer</b>	<b>Heating circuit pump Heating circuit with mixer</b>	<b>Cylinder loading pump</b>
13	OFF	OFF	Control funct.	OFF
14	OFF	OFF	OFF	Control funct.
15	OFF	OFF	OFF	OFF
16	ON	Control funct.	Control funct.	Control funct.
17	ON	Control funct.	Control funct.	OFF
18	ON	Control funct.	OFF	Control funct.
19	ON	Control funct.	OFF	OFF
20	ON	OFF	Control funct.	Control funct.
21	ON	OFF	Control funct.	OFF
22	ON	OFF	OFF	Control funct.
23	ON	OFF	OFF	OFF

<b>Coding in the as delivered condition Address: value</b>	<b>Function mode</b>	<b>Coding change Address: value</b>	<b>Possible change</b>
<b>Boiler/burner</b>			
50:0	Alternative control (automatic adjustment upon recognition of the operating interface)	50:1	Constant temperature control units
		50:3	Weather-compensated control units
52:0	Without flow temperature sensor for low loss header	52:1	With flow temperature sensor for low loss header (automatic adjustment upon recognition)

## Coding

**Code 2** (cont.)

<b>Coding in the as delivered condition Address: value</b>	<b>Function mode</b>	<b>Coding change Address: value</b>	<b>Possible change</b>
53:1	Function relay 2 of the internal extension: DHW circulation pump	53:0	Function relay 2: Central fault
		53:2	Function relay 2: External heating circuit pump (heating circuit without mixer)
		53:3	Function relay 2: External cylinder loading pump
54:0	Without solar control unit	54:1	With Vitosolic 100
		54:2	With Vitosolic 200 (automatic adjustment on recognition)
<b>Domestic hot water</b>			
56:0	DHW temperature adjustable from 10 to 60 °C	56:1	DHW temperature adjustable from 10 to 95 °C (only for gas fired boilers) Observe the max. permissible DHW temperature
58:0	Without auxiliary function for DHW loading	58:1 to 58:95	Input of set DHW value 2; adjustable from 1 to 95 °C (observe coding address 56)
59:0	DHW cylinder loading: Starting point -2.5 K Stopping point +2.5 K	59:1 to 59:10	Starting point adjustable from 1 to 10 K below the set value
5b:0	DHW cylinder directly connected to the boiler	5b:1	DHW cylinder connected downstream of the low loss header
60:10	*1During DHW loading, the boiler water temperature is up to 20 K higher than the set DHW temperature	60:5 to 60:25	The difference between the boiler water temperature and the set DHW temperature is adjustable from 10 to 50 K

\*1Only for weather-compensated control units.



**Code 2** (cont.)

<b>Coding in the as delivered condition Address: value</b>	<b>Function mode</b>	<b>Coding change Address: value</b>	<b>Possible change</b>
62:2	Circulation pump with 2 minutes run-on time	62:0	Circulation pump without run-on
		62:1 to 62:15	Run-on time adjustable from 1 to 15 minutes
63:0	*1Without auxiliary function for DHW loading	63:1	Additional function: 1 x daily
		63:2 to 63:14	Every 2 to every 14 days
		63:15	2 x daily
65:...	Information regarding the type of diverter valve (not adjustable)	65:0	Without diverter valve
		65:1	Diverter valve by Viessmann
		65:2	Diverter valve by Wilo
		65:3	Diverter valve by Grundfos
67:40	In conjunction with Vito-solic solar control unit: Set DHW value 3	67:0 to 67:60	DHW set value adjustable from 0 to 60 °C
6C:100	Set speed internal DHW loading pump 100 %	6C:0 to 6C:100	Set speed adjustable from 0 to 100 %
6F:100	Max. output during DHW loading 100 %, defaulted by the boiler coding card	6F:0 to 6F:100	Max. output during DHW loading adjustable from 0 to 100 %
71:0	*2DHW circulation pump: On according to DHW time program	71:1	OFF during DHW loading to set value 1
		71:2	ON during DHW loading to set value 1
72:0	*2DHW circulation pump: ON according to time program	72:1	OFF during DHW loading to set value 2
		72:2	ON during DHW loading to set value 2

\*1Only for constant temperature control units.

\*2Only for weather-compensated control units.

Coding

**Code 2** (cont.)

<b>Coding in the as delivered condition Address: value</b>	<b>Function mode</b>	<b>Coding change Address: value</b>	<b>Possible change</b>
73:0	*1DHW circulation pump: ON according to time program	73:1 to 73:6	During the time program 1x/h ON for 5 minutes up to 6x/h ON for 5 minutes
		73:7	Constantly ON
<b>General</b>			
76:0	Without LON communication module	76:1	With LON communication module; automatic recognition
		76:2	With KM BUS/cascade communication module; automatic recognition
77:1	LON user number	77:2 to 77:99	LON user number, adjustable from 1 to 99: 1 - 4 = boiler 5 = cascade 10 - ... = Vitotronic 050 99 = Vitocom  <b>Note</b> <i>Allocate each number only once.</i>
79:1	Control unit is fault manager *1	79:0	Control unit is not fault manager
7b:1	Send time to LON *1	7b:0	Do not send time to LON
7E:0	*2Without flue gas cascade	7E:1	With flue gas cascade
7F:1	*2Detached house	7F:0	Multi-occupancy house Separate adjustment for holiday program and time program for DHW loading, as option

\*1Only for weather-compensated control units.

\*2Only for constant temperature control units.

**Code 2** (cont.)

<b>Coding in the as delivered condition Address: value</b>	<b>Function mode</b>	<b>Coding change Address: value</b>	<b>Possible change</b>
80:1	With 5 seconds' time delay for fault message; message will be issued, if a fault persists for at least 5 seconds	80:0	Without time delay
		80:2 to 80:199	Time delay adjustable from 10 to 995; 1 step = 5 s
81:1	Automatic summer/winter changeover	81:0	Manual summer/winter changeover
		81:2	The application of the radio clock module will be recognised automatically
		81:3	Accept time via LON
88 :0	Temperature display in Celsius	88 :1	Temperature display in Fahrenheit
90:128	Time constant for calculating the adjusted outside temperature 21.3 hours	90:0 to 90:199	Fast (low values) or slow (high values) matching of flow temperature subject to set value if the outside temperature changes; 1 step = 10 min
91:0	*1No external operating mode changeover via external extension	91:1	External heating program changeover applies to heating circuit without mixer
		91:2	External heating program changeover applies to heating circuit with mixer
		91:3	External heating program changeover applies to heating circuit without mixer and heating circuit with mixer
95:0	Without Vitocom 100 communication interface	95:1	With Vitocom 100 communication interface; automatic recognition

**Code 2** (cont.)

<b>Coding in the as delivered condition Address: value</b>	<b>Function mode</b>	<b>Coding change Address: value</b>	<b>Possible change</b>
97:0	*1The outside temperature of the sensor connected to the control unit is utilised internally	97:1	Outside temperature is adopted by the LON BUS
		97:2	The outside temperature of the sensor connected to the control unit will be utilised internally and transmitted via LON BUS to any connected Vitotronic 050.
98:1	Viessmann system numbers (in conjunction with monitoring of several systems via Vito-com 300)	98:1 to 98:5	System number adjustable from 1 to 5
9b:70	Minimum set boiler water temperature in case of external demand	9b:1 to 9b:127	Set temperature adjustable from 1 to 127 °C
9C:20	*1Monitoring LON users When there is no response from a user, values defaulted inside the control unit continue to be used for a further 20 minutes. Only then will a fault message be triggered.	9C:0	No monitoring
		9C:5 to 9C:60	Time adjustable from 5 to 60 minutes
9F:8	*1Differential temperature 8 K; only in conjunction with a mixer circuit	9F:0 to 9F:40	Differential temperature adjustable from 0 to 40 K
<b>Boiler circuit, mixer circuit</b>			
A0:0	*1Without remote control	A0:1	With Vitotrol 200 (automatic recognition)
		A0:2	With Vitotrol 300 (automatic recognition)

\*1Only for weather-compensated control units.



## Code 2 (cont.)

Coding in the as delivered condition Address: value	Function mode	Coding change Address: value	Possible change
A2:2	With DHW cylinder priority applicable to heating circuit pump and mixer	A2:0	Without DHW cylinder priority applicable to heating circuit pump and mixer
		A2:1	With DHW priority applicable to mixer: The mixer is closed whilst DHW is loaded; the heating circuit pump operates *1
		A2:3 to A2:15	Reduced priority appl. to mixer; i.e. the heating circuit receives a reduced amount of energy *1
A3:2	<p>*2Outside temperature below 1 °C: Heating circuit pump ON Outside temperature above 3 °C: Heating circuit pump OFF</p> <p><b>Note</b> <i>When selecting a value below 1 °C there will be a risk of pipes outside the thermal insulation envelope of the house freezing-up. The standby mode, in particular, should be observed, e.g. during holidays.</i></p>	A3:-9 to A3:15	Heating circuit pump ON/OFF (see the following table)

\*1Only adjustable for mixer circuit M2.

\*2Only for weather-compensated control units.

Coding

**Code 2** (cont.)

Parameters Address A3:...	Heating circuit pump	
	ON at	OFF at
-9	-10 °C	-8 °C
-8	-9 °C	-7 °C
-7	-8 °C	-6 °C
-6	-7 °C	-5 °C
-5	-6 °C	-4 °C
-4	-5 °C	-3 °C
-3	-4 °C	-2 °C
-2	-3 °C	-1 °C
-1	-2 °C	0 °C
0	-1 °C	1 °C
1	0 °C	2 °C
2	1 °C	3 °C
to	to	
15	14 °C	16 °C

Coding in the as delivered condition Address: value	Function mode	Coding change Address: value	Possible change
<b>Boiler circuit, mixer circuit</b>			
A4:0	*1With frost protection	A4:1	No frost protection, adjustment only possible if code A3:-9 is selected.  <b>Note</b> <i>When selecting a value below 1 °C there will be a risk of pipes outside the thermal insulation envelope of the house freezing-up. The standby mode, in particular, should be observed, e.g. during holidays.</i>

\*1Only for weather-compensated control units.

**Code 2** (cont.)

<b>Coding in the as delivered condition Address: value</b>	<b>Function mode</b>	<b>Coding change Address: value</b>	<b>Possible change</b>
A5:5	* <sup>1</sup> With heating circuit pump logic function (economy circuit): Heating circuit pump OFF, if the outside temperature (AT) is 1 K higher than the set room temperature (RT <sub>Set</sub> ) AT > RT <sub>Set</sub> +1 K	A5:0  A5:1 to A5:15	Without heating circuit pump logic function  With heating circuit pump logic function: Heating circuit pump OFF, if (see the following table)

<b>Parameter address A5:...</b>	<b>With heating circuit pump logic function: Heating circuit pump OFF, if</b>
1	AT > RT <sub>Set</sub> +5 K
2	AT > RT <sub>Set</sub> +4 K
3	AT > RT <sub>Set</sub> +3 K
4	AT > RT <sub>Set</sub> +2 K
5	AT > RT <sub>Set</sub> +1 K
6	AT > RT <sub>Set</sub>
7	AT > RT <sub>Set</sub> -1 K
to 15	AT > RT <sub>Set</sub> - 9 K

\*<sup>1</sup>Only for weather-compensated control units.

**Code 2** (cont.)

Coding in the as delivered condition Address: value	Function mode	Coding change Address: value	Possible change
<b>Boiler circuit, mixer circuit</b>			
A6:36	*1Extended economy circuit <b>inactive</b>	A6:5 to A6:35	Extended economy circuit enabled, i.e. the burner and heating circuit pump will be switched OFF, and the mixer will be closed at a variable value, which is adjustable between 5 and 35 °C plus 1 °C. This value is based on the adjusted outside temperature, comprising the actual outside temperature and a time constant, which takes the cooling down of an average building into consideration.
A7:0	*1Without mixer economy function	A7:1	With mixer economy function (extended heating circuit pump logic): Heating circuit pump also OFF, if the mixer was closed for longer than 20 minutes. Heating pump ON, <ul style="list-style-type: none"> <li>■ if the mixer changes to control mode or</li> <li>■ after cylinder loading (for 20 min.) or</li> <li>■ if there is a risk of frost.</li> </ul> 

\*1Only for weather-compensated control units.



**Code 2** (cont.)

<b>Coding in the as delivered condition Address: value</b>	<b>Function mode</b>	<b>Coding change Address: value</b>	<b>Possible change</b>
A8:1	*1Heating circuit M2 (mixer circuit) creates a demand for the internal circulation pump	A8:0	Heating circuit M2 (mixer circuit) creates no demand for the internal circulation pump
A9:7	*1With pump idle period: Heating circuit pump OFF in case of set value modification (by changing the operating mode or changing the set room temperature)	A9:0	*1Without pump idle period
		A9:1 to A9:15	With pump idle time, adjustable from 1 to 15
b0:0	*1With remote control: Heating mode/reduced mode: Weather-compensated*2	b0:1	Heating mode: Weather-compensated Reduced mode: With room temperature hook-up
		b0:2	Heating mode: With room temperature hook-up Reduced mode: Weather-compensated
		b0:3	Heating mode/reduced mode: With room temperature hook-up
b2:8	With remote control unit and for the heating circuit, heating with room temperature hook-up must be encoded: Room influence factor 8*2	b2:0	Without room influence
		b2:1 to b2:64	Room influence factor adjustable from 1 to 64

\*1Only for weather-compensated control units.

\*2Change the coding for the heating circuit without mixer A1 or for mixer circuit M2, if the remote control unit affects that heating circuit.

**Code 2** (cont.)

Coding in the as delivered condition Address: value	Function mode	Coding change Address: value	Possible change
b5:0	*1With remote control: Without room temperature-dependent heating circuit pump logic function*2	b5:1 to b5:8	Heating circuit pump logic function - see the following table

Parameter address b5:...	With heating circuit pump logic function: Heating circuit pump OFF, if
1:	active $RT_{Actual} > RT_{Set} + 5 \text{ K}$ ; passive $RT_{Actual} < RT_{Set} + 4 \text{ K}$
2:	active $RT_{Actual} > RT_{Set} + 4 \text{ K}$ ; passive $RT_{Actual} < RT_{Set} + 3 \text{ K}$
3:	active $RT_{Actual} > RT_{Set} + 3 \text{ K}$ ; passive $RT_{Actual} < RT_{Set} + 2 \text{ K}$
4:	active $RT_{Actual} > RT_{Set} + 2 \text{ K}$ ; passive $RT_{Actual} < RT_{Set} + 1 \text{ K}$
5:	active $RT_{Actual} > RT_{Set} + 1 \text{ K}$ ; passive $RT_{Actual} < RT_{Set}$
6:	active $RT_{Actual} > RT_{Set}$ ; passive $RT_{Actual} < RT_{Set} - 1 \text{ K}$
7:	active $RT_{Actual} > RT_{Set} - 1 \text{ K}$ ; passive $RT_{Actual} < RT_{Set} - 2 \text{ K}$
8:	active $RT_{Actual} > RT_{Set} - 2 \text{ K}$ ; passive $RT_{Actual} < RT_{Set} - 3 \text{ K}$

Coding in the as delivered condition Address: value	Function mode	Coding change Address: value	Possible change
<b>Boiler circuit, mixer circuit</b>			
C5:20	*1Electronic limit of the minimum flow temperature: 20 °C	C5:1 to C5:127	Minimum limit adjustable from 1 to 127 °C
C6:74	*1Electronic limit of the maximum flow temperature: 74 °C	C6:0 to C6:127	Maximum limit adjustable from 1 to 127 °C
d3:14	*1Heating curve slope = 1.4	d3:2 to	Heating curve slope adjustable from 0.2 to 3.5

\*1Only for weather-compensated control units.

\*2Change the coding for the heating circuit without mixer A1 or for mixer circuit M2, if the remote control unit affects that heating circuit.

**Code 2** (cont.)

<b>Coding in the as delivered condition Address: value</b>	<b>Function mode</b>	<b>Coding change Address: value</b>	<b>Possible change</b>
		d3:35	(see page 33)
d4:0	* <sup>3</sup> Heating curve level = 0	d4:–13 to d4:40	Heating curve level adjustable from –13 to 40 (see page 33)
d5:0	* <sup>3</sup> The external operating mode changeover changes the heating program to "Constant operation with reduced room temperature"	d5:1	The external operating mode changeover changes the heating program to "Constant operation with standard room temperature"
E1:1	* <sup>3</sup> With remote control: Set day value is adjustable at the remote control unit from 10 to 30 °C	E1:0	Set day value adjustable from 3 to 23 °C
		E1:2	Set day value adjustable from 17 to 37 °C
E2:50	* <sup>3</sup> With remote control unit and for the heating circuit, heating with room temperature hook-up must be encoded: No display correction of the actual room temperature	E2:0 to E2:49	Display correction – 5 K or Display correction – 0.1 K
		E2:51 to E2:99	Display correction +0.1 K or Display correction +4.9 K
E5:0	* <sup>3</sup> Without variable speed circuit pump	E5:1	With variable speed circuit pump; automatic recognition
E6:65	* <sup>3</sup> Max. speed of the variable speed pump = 65 % of max. speed in standard mode	E6:0 to E6:100	Maximum speed adjustable from 0 to 100 % of max. speed
E7:30	* <sup>3</sup> Min. speed of the variable speed pump = 30 % of max. speed	E7:0 to E7:100	Minimum speed adjustable from 0 to 100 % of max. speed
E8:1	* <sup>3</sup> Min. speed subject to the setting in coding address E9	E8:0	Speed subject to the setting in coding address E7

Coding

**Code 2** (cont.)

Coding in the as delivered condition Address: value	Function mode	Coding change Address: value	Possible change
E9:45	*1Speed of the variable speed pump = 45 % of max. speed in reduced mode	E9:0 to E9:100	Speed adjustable from 0 to 100 % of max. speed
<b>Mixer circuit</b>			
F1:0	Screed drying function disabled *1	F1:1 to F1:5	<p>Screed drying function adjustable in accordance with 5 optional temperature time profiles (see page 104)</p> <p><b>Note</b> <i>Observe the screed drying supplier's instructions.</i></p> <p>Observe DIN 4725-2 or local regulations. The report to be provided by the heating contractor must contain the following heat-up details:</p> <ul style="list-style-type: none"> <li>■ Heat-up data with respective flow temperatures</li> <li>■ Max. flow temperature achieved</li> <li>■ Operating condition and outside temperature during handover.</li> </ul> <p>The function continues after power failure or after the control unit has been switched OFF. The heating program  will be started, after the</p>

\*1Only for weather-compensated control units.



## Code 2 (cont.)

Coding in the as delivered condition Address: value	Function mode	Coding change Address: value	Possible change
			screed-drying function has been completed or if the address is manually set to 0.
		F1:6 to F1:15	Constant flow temperature 20 °C
F2:8	*2Time limit for party operation 8 hours or external operating mode changeover via push button*3	F2:0	No time limit for party mode
		F2:1 to F2:12	Time limit adjustable from 1 to 12 hours*3*3
F5:12	Run-on time of the internal circulation pump in heating mode	F5:0	No run-on time of the internal circulation pump
		F5:1 to F5:20	Run-on time of the internal circulation pump adjustable from 1 to 20 minutes
F6:0	*4In "DHW only" operating mode, the internal circulation pump is permanently OFF	F6:1 to F6:24	In "DHW only" operating mode, the internal circulation pump will be started 1 to 24 times per day for 10 minutes respectively
		F6:25	In "DHW only" operating mode, the internal circulation pump is permanently ON
F7:0	*4In "Standby mode", the internal circulation pump is permanently OFF	F7:0	In "Standby mode", the internal circulation pump is permanently OFF
		F7:1 to	In "Standby mode", the internal circulation pump

\*2Only for weather-compensated control units.

\*3In heating program III , the party mode ends **automatically** when changing over to operation with standard room temperature.

\*4Only for constant temperature control units.









## Coding

### Code 2 (cont.)







































Coding in the as delivered condition Address: value	Function mode	Coding change Address: value	Possible change
		F7:24	will be started 1 to 24 times per day for 10 minutes respectively
		F7:25	* <sup>5</sup> In "Standby mode", the internal circulation pump is permanently ON

### Resetting the coding to the delivered condition

1. Press  and  simultaneously for approx. 2 seconds.
2. Press .  
Confirm "Basic setting? Yes" with .  
With  or , you can select "Basic setting? Yes" or "Basic setting? No".

\*<sup>5</sup>Only for constant temperature control units.

## Service level summary

Function	Key combination	Exit	Page
Temperatures, boiler coding card and brief scans	Press  and  simultaneously for approx. 2 seconds	Press 	64
Relay test	Press  and  simultaneously for approx. 2 seconds	Press 	68
Max. output (heating mode)	Press  and  simultaneously for approx. 2 seconds	Press 	16
Operating condition	Press 	Press 	70
Maintenance scan	 (if "Maintenance" flashes)	Press 	–
Adjusting the display contrast	Press  and  simultaneously; display darkens	–	–
	Press  and  simultaneously; display becomes lighter	–	–
Fault history	Press  and  simultaneously for approx. 2 seconds	–	–
User check (in conjunction with LON system)	Press  and  simultaneously for approx. 2 seconds	–	–
Emissions test function 	Press  and  simultaneously for approx. 2 seconds	Press  and  simultaneously	–
Coding level 1 Plain text display	Press  and  simultaneously for approx. 2 seconds	Press  and  simultaneously	38
Coding level 2 Numerical display	Press  and  simultaneously for approx. 2 seconds	Press  and  simultaneously	42
Max. output in heating mode	Press  and  simultaneously for approx. 2 seconds	Press  and  simultaneously	16

## Temperatures, boiler coding card and brief scans

### Weather-compensated control units

1. For two heating circuits – select heating circuit:
  - Press (+).
  - 1 flashes on the display.
  - Select heating circuit A1 (heating circuit without mixer):  
Press (OK).
  - Select heating circuit M2 (heating circuit with mixer):
    - Press (+).
    - 2 flashes on the display.
    - Press (OK).
2. Press and simultaneously for approx. 2 seconds.
3. Select the required scan with (+) and (-).
4. Press (OK).

The following values can be scanned, subject to the actual equipment level:







- Slope A1 – Level A1
- Slope M2 – Level M2
- Adj. outside temp.
- Outside temp., actual
- Boiler temp., set
- Boiler temp., actual
- DHW temp., set
- DHW temp., actual
- DHW outlet temp., actual
- DHW outlet temp., set
- Flow temperature, set
- Flow temperature, actual
- Mixed flow temp., set
- Mixed flow temp., actual
- Boiler coding card
- Brief scan 1  
to  
Brief scan 8

The adjusted outside temperature can be reset to the current outside temperature with (+).

Heating circuit with mixer  
Heating circuit with mixer  
Low loss header  
Low loss header



### Temperatures, boiler coding card and brief scans (cont.)





	Display screen					
<b>Brief scan</b>						
Boiler coding card	N/A	N/A	X	X	X	X
1	Software version Control unit		Version Boiler (EEPROM)		Version Burner control unit (EEPROM)	
2	System design 1 to 6 indication in accordance with the relevant design		Display KM BUS users	Max. demand temperature		
3	N/A	Software version Programming unit	Software version Mixer extension kit	Software version Solar control unit	Software version LON system	Software version Ext. extension
4	Software version Burner control unit		Type Burner control unit		Boiler type	
5	0: No ext. demand or operating mode change-over 1: Ext. demand or operating mode change-over present	0: No ext. blocking 1: Ext. blocking present	N/A	External hook-up 0 to 10 V, displayed in %		
6	Number of LON users		Software version Third party controller	Max. output, displayed in %		



**Temperatures, boiler coding card and brief scans (cont.)**

		Display screen					
Brief scan	0	0	0	0	0	0	
			Heating circuit 1 (boiler circuit A1)		Heating circuit 2 (mixer circuit M2)		
7	N/A	N/A	Remote control 0: excl. 1: Vito-trol 200 2: Vito-trol 300	Software version Remote control	Remote control 0: excl. 1: Vito-trol 200 2: Vito-trol 300	Software version Remote control	
	Internal circulation pump		Heating circuit pump boiler circuit A1		Heating circuit pump mixer circuit M2		
8	Variable speed pump 0: excl. 1: Wilo 2: Grundfos	Software version Variable speed pump	Variable speed pump 0: excl. 1: Wilo 2: Grundfos	Software version Variable speed pump	Variable speed pump 0: excl. 1: Wilo 2: Grundfos	Software version Variable speed pump	

**Constant temperature control units**

1. Press  and  simultaneously for approx. 2 seconds.  
Scanning enabled.
2. Select the required scan with  and .
3. Press .  
Scanning is completed.

### Temperatures, boiler coding card and brief scans (cont.)

Display screen					
Brief scan	0	0	0	0	0
0		System design, indication in accordance with the design	Software version Control unit		Software version User interface
1	Software version Solar panel	Software version Burner control unit		Software version Ext. extension	Software version Cascade module
E	0: No ext. demand or operating mode change-over 1: Ext. demand or operating mode change-over present	0: No ext. blocking 1: Ext. blocking present	External hook-up 0 to 10 V, displayed in %		
3			Set boiler temperature at the boiler temperature sensor		
A			Highest demand temperature		
4		Burner control unit type	Boiler type		
5			Set cylinder temperature at the cylinder temperature sensor (current value)		
b			Max. heating output in %		
C		Boiler coding card (hexa-decimal)			
c		Version Equipment (EEPROM)		Version Burner control unit (EEPROM)	







## Service scans

### Temperatures, boiler coding card and brief scans (cont.)

Brief scan	Display screen				
	0	0	0	0	0
d				Variable speed pump 0: excl. 1: Wilo 2: Grundfos	Software version Variable speed pump

### Checking outputs (relay test)

#### Weather-compensated control units

1. Press  and  simultaneously for approx. 2 seconds.  
Relay test enabled.
2. Select the relay outputs with  and .
3. Press .  
Relay test is completed.





Subject to the actual equipment level, the following relay outputs can be controlled:

Display	Description
Basic load	Burner modulation lower output
Full load	Burner modulation upper output
Heating valve	Diverter valve set to heating mode
Valve central pos.	Changeover valve in central position (fill)
DHW valve	Diverter valve set to DHW mode
Int. pump ON	Int. pump/output 20 ON
Close mixer	Mixer extension
Open mixer	Mixer extension
Heating circ. pump M2 ON	Mixer extension
Output int.	Internal extension
Heating circ. pump A1 ON	Ext. extension
Cylinder loading pump ON	Ext. extension
DHW circ. pump ON	Ext. extension
Central fault display ON	Ext. extension

### Checking outputs (relay test) (cont.)

Display	Description
Solar pump ON	Vitosolic

### Constant temperature control units



1. Press  and  simultaneously for approx. 2 seconds.  
Relay test enabled.
2. Select the relay outputs with  and .
3. Press .  
Relay test enabled.

Subject to the actual equipment level, the following relay outputs can be controlled:

Display	Description
1	Burner modulation lower output
2	Burner modulation upper output
3	Diverter valve set to heating mode
4	Valve in central position
5	Valve set to DHW mode
6	Internal pump/output 20 ON
10	Output  internal extension
11	Heating circuit pump A1 external extension
12	Cylinder loading pump external extension
13	DHW circulation pump external extension
14	Central fault external extension

## Scanning operating conditions and sensors

### Weather-compensated control units

1. Select a heating circuit:
  - Press (+).
  - 1  flashes on the display.
  - Select heating circuit A1 (heating circuit without mixer):  
Press (OK).
  - Select heating circuit M2 (heating circuit with mixer):
    - Press (+).
    - 2  flashes on the display.
    - Press (OK).
2. Press (i).
3. Select the required operating condition scan with (+) or (-).
4. Press (i).

### Heating circuits A1 and M2





Operating condition display (subject to system equipment level)	Description
User no.	Encoded user no. in the LON system
Holiday program	Displayed only if a holiday program has been set up
Date of departure	Date
Date of return	Date
Outside temperature, ... °C	Actual value
Boiler temperature, ... °C	Actual value
Flow temperature, ... °C	Actual value (only for heating circuit M2)
Standard room temperature, ... °C	Set value
Room temperature, ... °C	Actual value
Ext. set room temp., ... °C	If external hook-up
DHW temperature, ... °C	Actual DHW temperature
Solar DHW temp., ... °C	Actual value
Collector temperature, ... °C	Actual value
Mixed flow temp., ... °C	Actual value, only with low loss header
Burner, ...h*1	Hours run
Burner starts, ...*1*1	Actual value
Solar energy	Displayed in kW/h
Time	
Date	

\*1 Reset hours run and burner starts after maintenance has been completed. You can reset the hours run to 0 by pressing (+).

### Scanning operating conditions and sensors (cont.)

Operating condition display (subject to system equipment level)	Description
Burner OFF or ON	
Int. pump OFF or ON	Output 20
Int. output OFF or ON	Internal extension
Heating pump OFF or ON	External extension or extension kit for one heating circuit with mixer installed
Cylinder loading pump OFF or ON	Displayed only if the external extension is installed
DHW circulation pump OFF or ON	Displayed only if the external extension is installed
Central fault display OFF or ON	Displayed only if the external extension is installed
Mixer, mixer open or mixer close	Display only if the extension kit for one heating circuit with mixer is installed
Solar pump OFF or ON	Displayed only if Vitosolic is installed
Solar pump ...h	Hours run
Various languages	Each language can be selected as permanent display language with  .

### Constant temperature control units

- Press .
- Select the required operating condition scan with  or .
- Press .

Operating condition display (subject to system equipment level)	Description
0            01	Equipment no. in case of multi-boiler systems
1            15 °C/°F*1	Outside temperature sensor - actual value (only if an outside temperature sensor is connected)
3            65 °C/°F*1	Boiler temperature sensor - actual value
5            50 °C/°F*1	Cylinder temperature sensor - actual value
5□          45 °C/°F*1	Solar - actual DHW temperature
6            70 °C/°F*1	Actual value - collector sensor

\*1 Displayed in °F if the relevant code has been selected and with the fourth display digit.

Service scans

**Scanning operating conditions and sensors (cont.)**

<b>Operating condition display (subject to system equipment level)</b>	<b>Description</b>
263572      h	Burner hours run
030529	Burner starts
001417      h	Hours run - solar circuit pump
002850	Solar energy in kW/h



## Calling up fault code history

The most recent 10 faults are saved and may be called up.

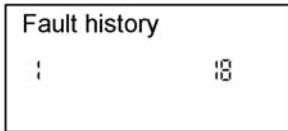

1. Press and simultaneously for approx. 2 seconds.
2. Call up the individual fault codes with or .

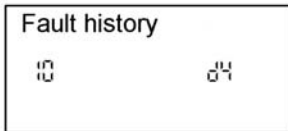

Fault code order	Fault code
1	most recent
.	.
.	.
.	.
10	10th from most recent

All saved fault codes can be deleted with .

3. Press .

## Call up current fault codes

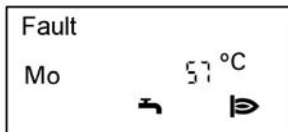

Red fault indicator flashes for all faults.  
"Fault" flashes in the programming unit display when a fault message is issued.



A fault in the burner control unit causes the display to flash .

## Call up current fault codes (cont.)

### Control unit faults

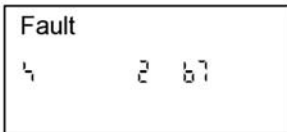
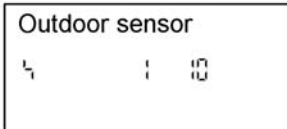

1. Find current fault with **i**.

2. Select additional fault codes with **+** and **-**.

#### 3. Acknowledge fault.

The fault can be acknowledged with **OK**. The fault message in the display will be hidden, but red fault indicator **A** continues to flash. A new fault message will be shown in the display if an acknowledged fault is not removed by 07:00 h the following day.

### Fault on the burner control unit

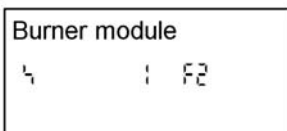

1. Find current fault with **i**.

2. Select additional fault codes with **+** and **-**.

#### 3. Acknowledge fault.

The fault can be acknowledged with **OK**. The fault message in the display will be hidden, but red fault indicator **A** continues to flash. A new fault message will be shown in the display if an acknowledged fault is not removed by 07:00 h the following day.

**Call up current fault codes (cont.)**

**Fault display design**

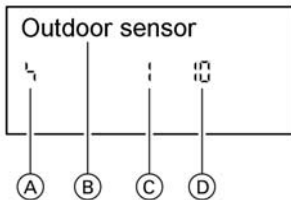

- (A) Fault symbol
- (B) Plain text fault display (only for weather-compensated control units)
- (C) Fault number
- (D) Fault code

**1. Calling up acknowledged fault messages**

Press **OK** for approx. 3 seconds.  
The fault will then be displayed.

4. **⌊** in the display indicates that the burner control unit is locked out.  
After the fault has been removed, acknowledge by pressing reset **⌊**.

Plain text fault display

- Burner control unit
- Outside temperature sensor
- Flow sensor
- Boiler sensor
- Mixed flow sensor
- DHW cylinder sensor
- Flue gas sensor
- DHW outlet sensor
- Room temperature sensor
- Collector sensor
- Solar DHW sensor
- Remote control

2. Select the acknowledged fault with **+** or **-**.

**Checking and acknowledging faults**

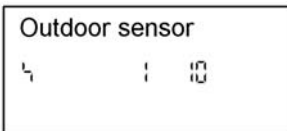

Weather-compensated control units

Red fault indicator **⌊** flashes for all faults.

A fault message code flashes in the programming unit display when a fault message is issued.

Any fault codes present may be called up with **+** or **-**.

## Checking and acknowledging faults (cont.)



Constant temperature control units

### Note

The fault can be acknowledged with **OK**. The fault message in the display will be hidden, but the red fault indicator **|** continues to flash. A new fault message will be displayed if an acknowledged fault is not removed by the following morning.

### Calling up acknowledged fault messages

Press **OK** for approx. 2 seconds; select the acknowledged fault with **+** or **-**.

Displayed fault code	Const.	Weather-comp.	System characteristics	Cause	Remedy
0F	X	X	Control mode	Maintenance	Carry out maintenance. Set code 24:0 after maintenance
10	X	X	Controls according to 0 °C outside temperature	Outside temperature sensor shorted out	Check the outside temperature sensor (see page 85)
18	X	X		Outside temperature sensor lead break	
20	X	X	Controls without flow temperature sensor (low loss header)	System flow temperature sensor shorted out	Check the low loss header sensor (see page 87)
28	X	X		System flow temperature sensor lead break	

**Checking and acknowledging faults** (cont.)

Displayed fault code	Const.	Weather-comp.	System characteristics	Cause	Remedy
30	X	X	Burner blocked	Boiler temperature sensor shorted out	Check the boiler temperature sensor (see page 87)
38	X	X		Boiler temperature sensor lead break	
40		X	Mixer closes	Heating circuit M2 flow temperature sensor shorted out	Check the flow temperature sensor
48		X		Heating circuit M2 flow temperature sensor lead break	
50	X	X	No DHW heating	Cylinder temperature sensor shorted out	Check the cylinder temperature sensor (see page 87)
58	X	X		Cylinder temperature sensor lead break	
51	X	X	No DHW heating	Cylinder temperature sensor 2 shorted out	Check the cylinder temperature sensor (see page 87)
59	X	X		Cylinder temperature sensor 2 lead break	
92	X	X	Control mode	Solar: Collector temperature sensor shorted out	Check sensor
9A	X	X		Collector temperature sensor lead break	
93	X	X	Control mode	Solar: Sensor S3 shorted out	Check sensor
9b	X	X		Sensor S3 lead break	



**Checking and acknowledging faults (cont.)**

Displayed fault code	Const.	Weather-comp.	System characteristics	Cause	Remedy
94	X	X	Control mode	Solar: Cylinder temperature sensor shorted out	Check sensor
9C	X	X		Cylinder temperature sensor lead break	
9F	X	X	Control mode	Solar control unit fault message	See solar control unit service instructions
A7		X	Control mode	Faulty operating interface	Replace operating interface
b0	X	X	Burner blocked	Flue gas temperature sensor short circuit	Check the flue gas temperature sensor (see page 88)
b8	X	X		Flue gas temperature sensor break	
b1	X	X	Control mode	Communication fault – programming unit (internal)	Check connections and replace the programming unit, if necessary
b4	X	X	Emissions test mode	Internal fault analog converter	Replace control unit
b5	X	X	Control mode	Internal fault	Replace control unit
b7	X	X	Burner blocked	Boiler coding card missing, faulty or incorrect card inserted	Plug in the boiler coding card or replace, if faulty



**Checking and acknowledging faults (cont.)**

Displayed fault code	Const.	Weather-comp.	System characteristics	Cause	Remedy
bA		X	Mixer M2 continues to regulate	Communication fault - extension kit for mixer circuit M2	Check the extension kit connections and coding. Start the extension kit.
bC		X	Control mode without remote control	Communication fault - Vitotrol remote control heating circuit A1	Check connections, cable, coding address A0 and the remote control DIP switches
bd		X	Control mode without remote control	Communication fault - Vitotrol remote control heating circuit M2	
bE		X	Control mode	Vitotrol remote control incorrectly encoded	Check the DIP switch settings of the remote control
bF		X	Control mode	Incorrect LON communication module	Replace the LON communication module
C2	X	X	Control mode	Communication fault - solar control unit	Check connections and coding address 54
C5	X	X	Control mode, max. pump speed	Communication fault - variable speed internal pump	Check coding address 30 settings; check the heating circuit pump DIP switch settings





**Checking and acknowledging faults (cont.)**

Displayed fault code	Const.	Weather-comp.	System characteristics	Cause	Remedy
C6		X	Control mode, max. pump speed	Communication fault - variable speed heating circuit pump, heating circuit M2	Check coding address E5 settings; check the heating circuit pump DIP switch settings
C7	X	X	Control mode, max. pump speed	Communication fault - variable speed heating circuit pump, heating circuit A1	Check coding address E5 settings; check the heating circuit pump DIP switch settings
Cd	X	X	Control mode	Communication fault Vitocom 100 (KM BUS)	Check connections and Vitocom 100
CE	X	X	Control mode	Communication fault - ext. extension	Check connections and coding address 2E settings
CF		X	Control mode	Communications fault - LON communication module	Replace the LON communication module
dA		X	Control mode without room influence	Room temperature sensor heating circuit A1 shorted out	Check the room temperature sensor - heating circuit A1
db		X		Heating circuit M2 room temperature sensor shorted out	Check the room temperature sensor - heating circuit M2







**Checking and acknowledging faults (cont.)**

Displayed fault code	Const.	Weather-comp.	System characteristics	Cause	Remedy
dd		X		Room temperature sensor heating circuit A1 lead break	Check the room temperature sensor for heating circuit A1
dE		X		Heating circuit M2 room temperature sensor lead break	Check the room temperature sensor for heating circuit M2
E4	X	X	Burner blocked	Fault - supply voltage	Replace control unit
E5	X	X	Burner blocked	Internal fault	Check the ionisation electrode and leads. Check flue gas system for soundness. Press  .
E6	X	X	Burner in fault state	Flue gas/air supply system blocked	Check the flue gas/air supply system. Check the differential pressure sensor. Press  .
F0	X	X	Burner blocked	Internal fault	Replace control unit





**Checking and acknowledging faults (cont.)**

Displayed fault code	Const.	Weather-comp.	System characteristics	Cause	Remedy
F1	X	X	Burner in fault state	Flue gas temperature limiter has responded	Check the heating system water level. Vent the heating system. Press reset  <b>no sooner</b> than after 20 minutes.
F2	X	X	Burner in fault state	Temperature limiter has responded	Check the heating system water level. Check the circulation pump. Vent the heating system. Check the temperature limiter and leads. Press  .
F3	X	X	Burner in fault state	The flame signal is already present at burner start	Check the ionisation electrode and leads. Press  .





**Checking and acknowledging faults (cont.)**

Displayed fault code	Const.	Weat-her-comp.	System character-istics	Cause	Remedy
F4	X	X	Burner in fault state	No flame signal is present	Check the ionisation electrode and leads, measure the ionisation current, check the gas pressure, check the gas combination valve, ignition, ignition module, ignition electrodes and the condensate drain. Press  .
F7	X	X	Burner blocked	Differential pressure sensor faulty	Check the differential pressure sensor and lead.
F8	X	X	Burner in fault state	Fuel valve closes too late	Check gas combination valve. Check both control paths. Press  .
F9	X	X	Burner in fault state	Fan speed too low at burner start	Check the fan, check the fan cables and supply, check the fan control. Press  .



**Checking and acknowledging faults** (cont.)

Displayed fault code	Const.	Weat-her-comp.	System character-istics	Cause	Remedy
FA	X	X	Burner in fault state	Fan speed too high at burner start	Check the fan, check the fan cables, check the fan control. Press  .
Fd	X	X	Burner blocked	Burner control unit fault	Check the ignition electrodes and leads. Check whether a strong interference (EMC) field exists near the equipment. Press  . If the fault is not removed, replace the control unit.
FE	X	X	Burner blocked	Strong interference (EMC) field nearby; alternatively boiler coding card or main PCB faulty	Remove EMC interference. If the equipment will not restart, check the boiler coding card and replace, or replace the control unit.



### Checking and acknowledging faults (cont.)

Displayed fault code	Const.	Weather-comp.	System characteristics	Cause	Remedy
FF	X	X	Burner blocked	Internal fault	Remove EMC interference. If the equipment will not restart, check the boiler coding card and replace, or replace the control unit.

### Repairs

#### Checking the outside temperature sensor (weather-compensated control units)

1. Pull plug X3 from the control unit.

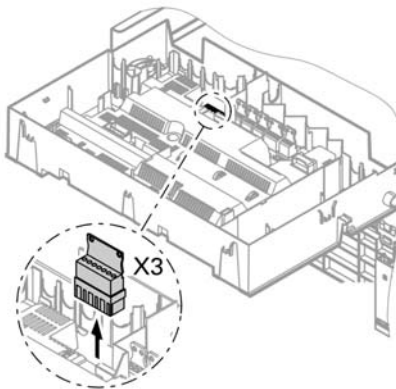

## Repairs (cont.)

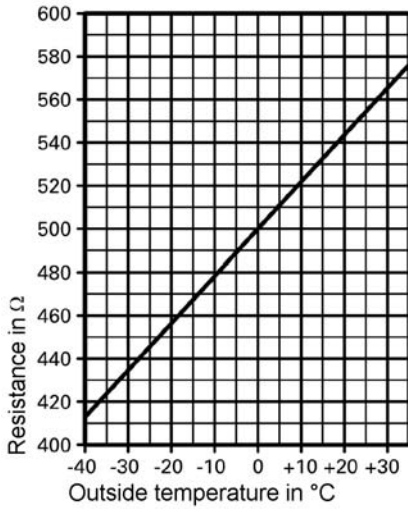

2. Test the resistance of the outside temperature sensor across terminals X3.1 and X3.2 on the disconnected plug and compare with the curve.
3. Where actual values strongly deviate from the curve values, disconnect the wires at the sensor and repeat test directly at the sensor.
4. Depending on the result, replace cable or outside temperature sensor.

**Repairs (cont.)**

**Check the boiler temperature sensor, cylinder temperature sensor or the flow temperature sensor for low loss header**

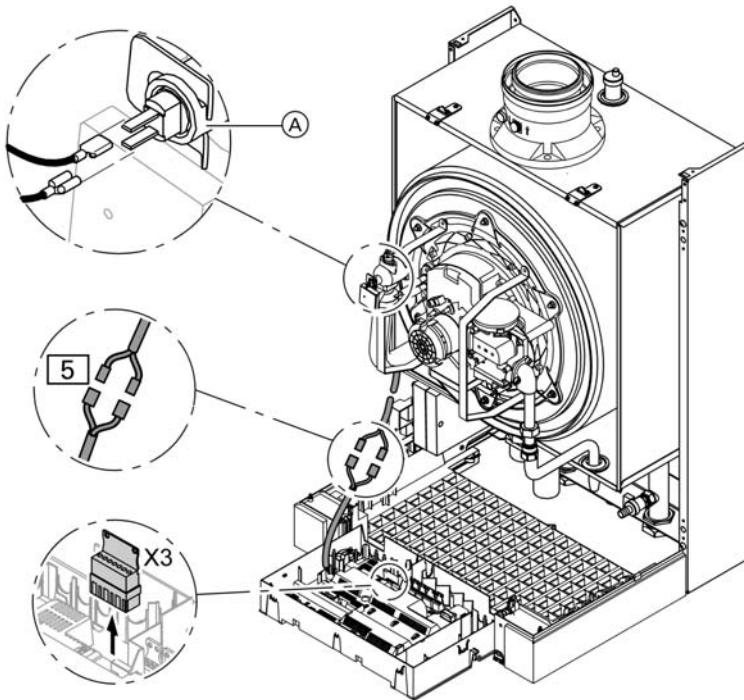

1. Boiler temperature sensor: Pull the leads from boiler temperature sensor **A** and measure the resistance.  
 Cylinder temperature sensor: Pull the plug **5** from the cable harness on the control unit and measure the resistance.  
 Flow temperature sensor: Pull plug **X3** from the control unit and measure the resistance across terminals X3.4 and X3.5.



## Repairs (cont.)

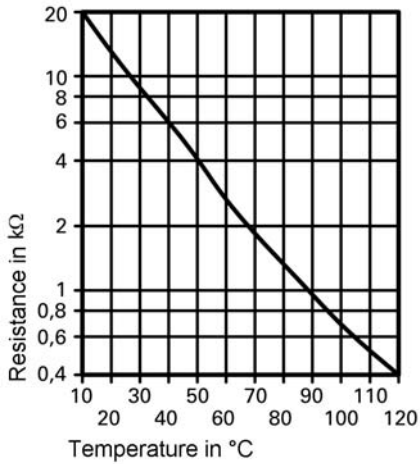

2. Check the sensor resistance and compare actual values with the curve.
3. Replace the sensor in case of severe deviation.



### **Danger**

The boiler temperature sensor is immersed in the heating water (risk of scalding). Drain the boiler before replacing the sensor.

## Checking the flue gas temperature sensor

The flue gas temperature sensor locks out the boiler when the permissible flue gas temperature is exceeded. The lockout can be reset no sooner than after 20 minutes by pressing reset .

### **Note**

*The equipment will also be locked out again for 20 minutes if the mains power supply is switched OFF.*



**Repairs** (cont.)

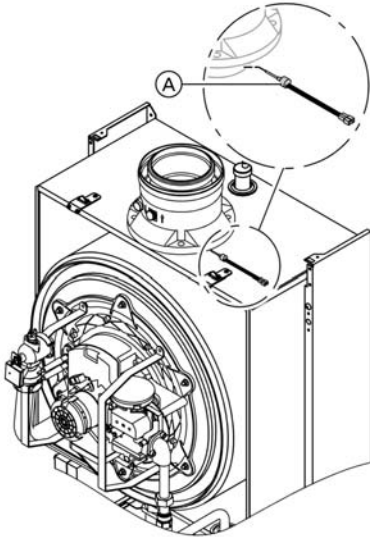

1. Pull the leads from the flue gas temperature sensor (A).
2. Check the sensor resistance and compare actual values with the curve.

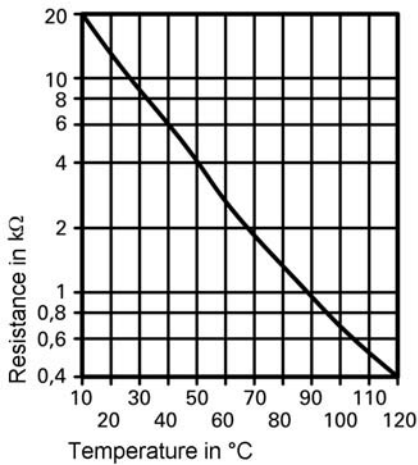

3. Replace the sensor in case of severe deviation.

## Repairs (cont.)

### Checking the thermocouple

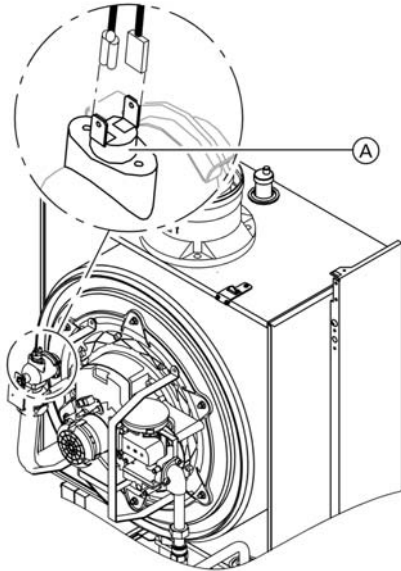

If the burner control unit cannot be reset after a fault shutdown, although the boiler water temperature is below approx. 90 °C:

- Pull the leads from thermocouple (A).
- Check the continuity of the thermocouple with a multimeter.
- Remove the faulty thermocouple.
- Install a new thermocouple.
- After commissioning, press reset button  on the control unit.

### Checking and replacing pressure differential sensor

*Check the sensor in case of fault messages concerning the differential pressure sensor:*

- *Correct installation*
- *Electrical connection*
- *Correct position of the O-rings inside the adaptor*
- *Are the test nipples closed with plugs?*

*Replace the sensor if fault messages persist.*

## Repairs (cont.)

### Checking O-rings:

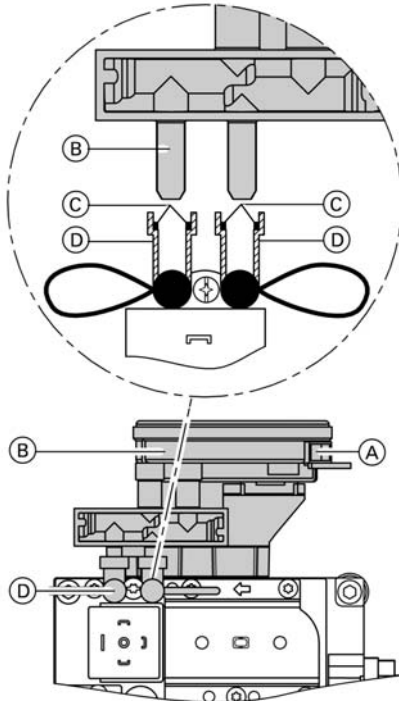

1. Pull off the electrical plug (A).
2. Remove sensor (B) by pulling it upwards.
3. Ensure that both O-rings (C) are properly inserted into aperture adaptor retainers (D).
4. Insert the sensor with connection nipples into the gas combination valve adaptor and push in until it clicks into place.
5. Reconnect the electrical plug-in connector on the sensor.

## Repairs (cont.)

### Checking the fuse

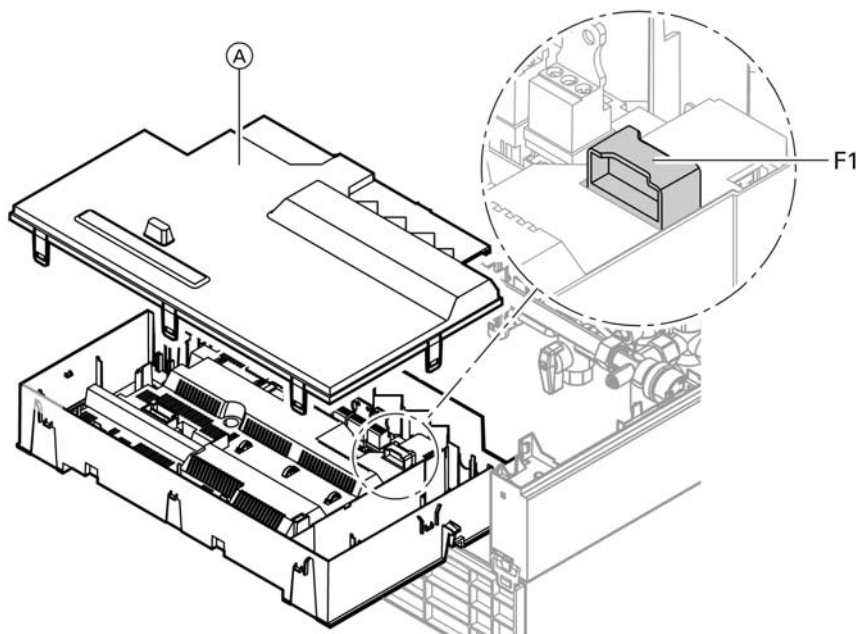

1. Switch OFF the mains power.
2. Release the lateral closures and pivot the control unit down.
3. Remove cover (A).
4. Check fuse F1.

**Repairs** (cont.)

**Extension kit for heating circuit with mixer**

**Checking the rotational direction of the mixer motor**

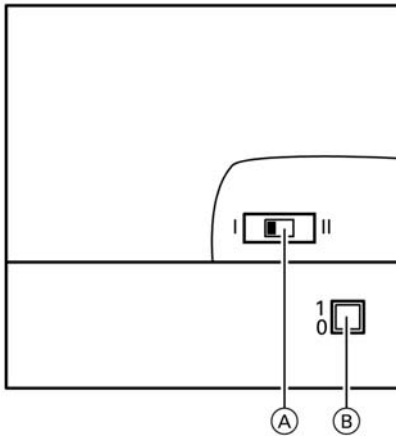

- (A) Rotational direction switch
- (B) ON/OFF switch ①

1. Switch OFF the motor and restart it at the main ON/OFF switch. The device will carry out the following self-test:
  - Mixer close (150 seconds)
  - Pump ON (10 seconds)
  - Mixer open (10 seconds)
  - Mixer close (10 seconds)
 Then standard control mode recommences.
2. Note the rotational direction of the mixer motor during the self-test. Then set the mixer manually to the "Open" position.

**Note**

*The flow temperature sensor must now sense a higher temperature. If the temperature falls, either the motor is turning in the wrong direction or the mixer set is incorrectly fitted.*



Mixer installation instructions

3. Adjust the rotational direction of the mixer motor (if required).
  - Switch position I for heating return from the l.h. side (as delivered condition).
  - Switch position II for heating return from the r.h. side.

## **Repairs** (cont.)

### **Checking Vitotronic 050 (accessory)**

Vitotronic 050 is connected with the control unit via the LON system. To test the connection, implement a user check on the boiler control unit (see page 32).

## Constant temperature control units

### Heating mode

The set boiler water temperature will be maintained in the "central heating and DHW heating"  program, when a demand is raised by the room temperature-dependent clock thermostat. If no demand is received, the boiler water temperature will be held at the defaulted frost protection temperature.

### DHW heating

The DHW heating will be activated if the cylinder temperature falls 2.5 K below the set cylinder temperature. The burner and the cylinder loading pump are switched ON. In the delivered condition, the set boiler temperature lies 20 K higher than the set DHW temperature (adjustable in coding address 60). If the actual cylinder temperature rises 2.5 K above the set cylinder temperature, the burner will be switched OFF and the cylinder loading pump run-on time will be activated.

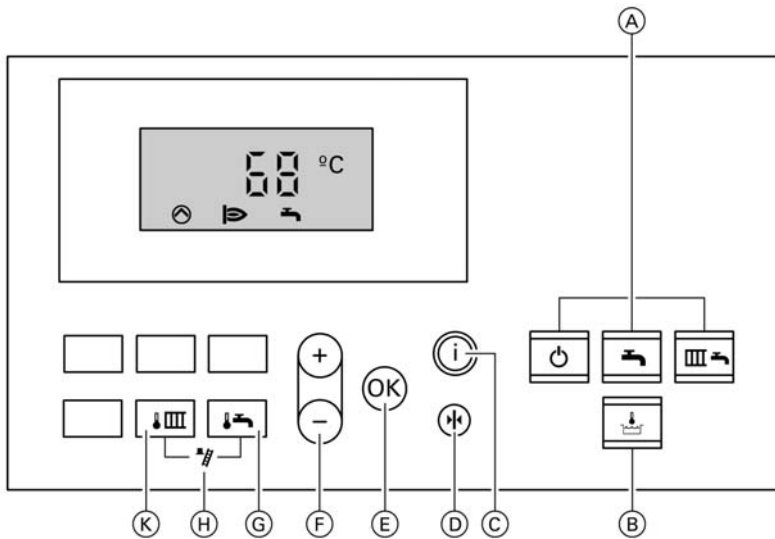

- (A) Heating programs
- (B) Comfort mode
- (C) Information
- (D) Basic settings
- (E) Confirmation/acknowledgement
- (F) Setting values
- (G) DHW temperature
- (H) Emissions test function
- (K) Boiler water temperature

## Weather-compensated control units

### Heating mode

The control unit determines a set boiler water temperature subject to outside temperature or room temperature (if a room temperature-dependent remote control is connected) and the slope/level of the heating curve. The determined set boiler water temperature is then transferred to the burner control unit. From the set and actual boiler water temperatures, the burner control unit calculates the modulation level and controls the burner accordingly. The burner control unit limits the boiler water temperature: through the control thermostat to 84 °C and through the electronic temperature limiter to 82 °C. The thermocouple in the safety chain locks out the burner control unit at a boiler water temperature of 100 °C.

### DHW heating

The DHW heating will be activated if the cylinder temperature falls 2.5 K below the set cylinder temperature. The burner and the cylinder loading pump are switched ON. In the delivered condition, the set boiler water temperature lies 20 K above the set cylinder temperature. If the actual cylinder temperature rises 2.5 K above the set cylinder temperature, the burner will be switched OFF and the cylinder loading pump run-on time will be activated.

### Supplementary DHW heating

The backup heating function is activated, if a switching period is selected for the fourth time phase. This period must lie outside the switching times for standard DHW heating to enable the control unit to recognise the signal. The set temperature value for backup heating is adjustable in coding address 58.



**Weather-compensated control units (cont.)**

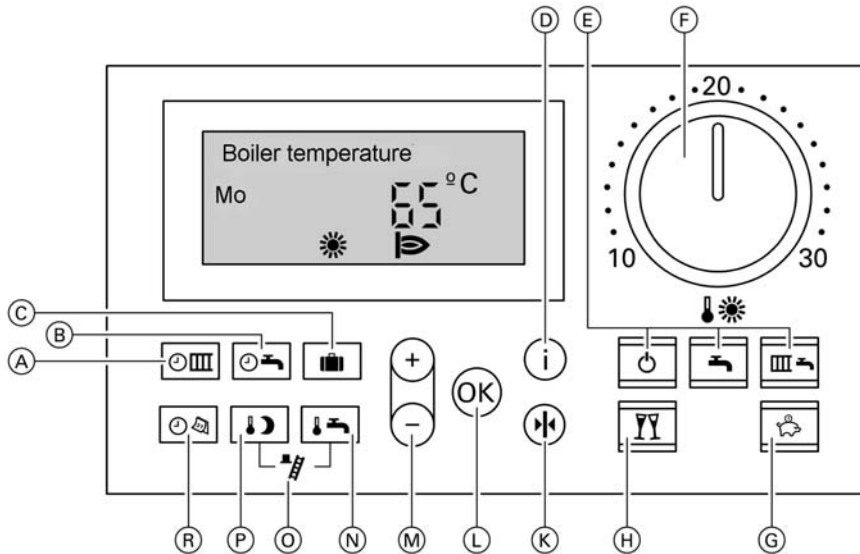

- |   |                                |
|---|--------------------------------|
| Ⓐ Heating circuit time program  | ⓓ Information                  |
| Ⓑ DHW time program and DHW circulation (if connected to the control unit) | ⓔ Heating programs             |
| Ⓒ Holiday program   | ⓕ Standard room temperature    |
| Ⓓ Information   | ⓖ Economy mode                 |
| ⓔ Heating programs  | ⓓ Party mode                   |
| ⓕ Standard room temperature   | ⓕ Basic settings               |
| ⓖ Economy mode  | ⓕ Confirmation/acknowledgement |
|   | ⓕ Setting values               |
|   | ⓕ DHW temperature              |
|   | ⓕ Emissions test function      |
|   | ⓕ Reduced room temperature     |
|   | ⓕ Date/time                    |

## Extensions for external connections (accessory)

### Internal extension H1

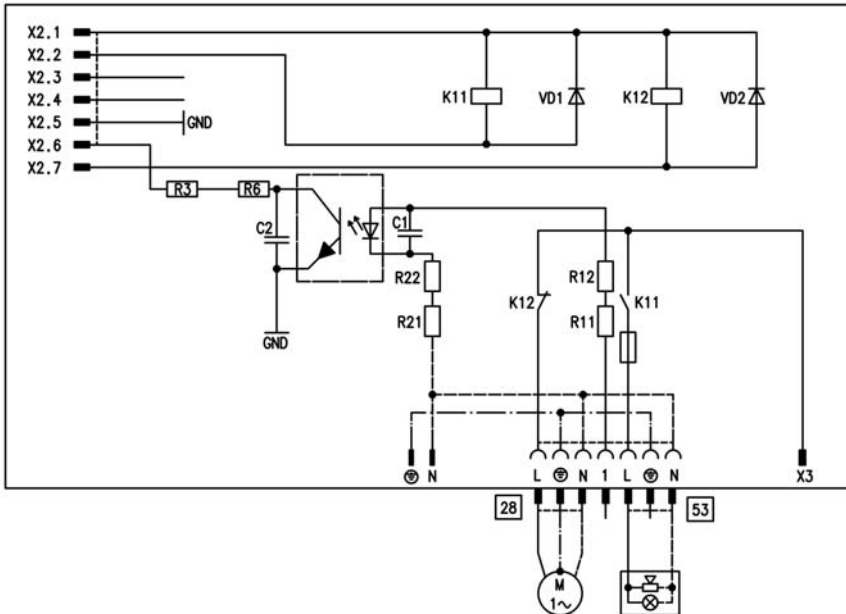

The internal extension is integrated into the control unit housing. As alternative, the following functions can be connected to relay output 28. The function is allocated via coding address 53:

- Central fault message (code 53:0)
- Cylinder loading pump (code 53:3)
- DHW circulation pump (code 53:1)
- Heating circuit pump for heating circuit without mixer (code 53:2)

An external safety valve can be connected to connection 53.

## Extensions for external connections (accessory) (cont.)

### Internal extension H2

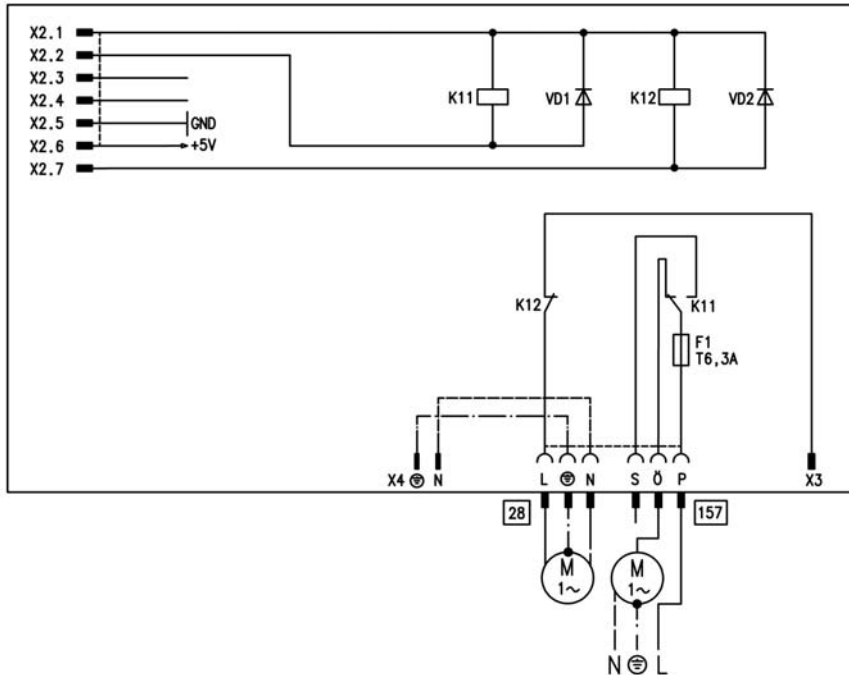

The internal extension is integrated into the control unit housing. As alternative, the following functions can be connected to relay output 28. The function is allocated via coding address 53:

- Central fault message (code 53:0)
- Cylinder loading pump (code 53:3)
- DHW circulation pump (code 53:1)
- Heating circuit pump for heating circuit without mixer (code 53:2)

An interlock for extractors can be connected to connection 157.

## Extensions for external connections (accessory) (cont.)

### External extension H1

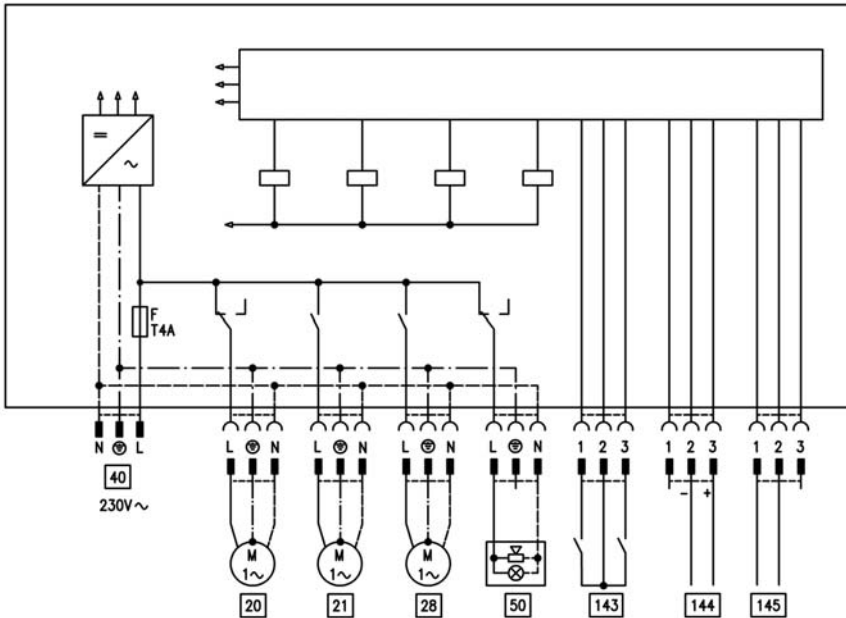

The external extension is connected to the boiler control unit via the KM BUS. The following functions can be controlled or processed via this extension:

- 20** Heating circuit pump for heating circuit without mixer
- 21** Cylinder loading pump
- 28** DHW circulation pump
- 40** Power supply
- 50** Central fault message

- 143** ■ External blocking (terminals 2 - 3)
- External demand (terminals 1 - 2)
- External operating mode changeover (terminals 1 - 2)
- 144** External set value 0 to 10 V
- 145** KM BUS

The allocation of the "External changeover of operating mode" function is selected via coding address 91.

**Extensions for external connections (accessory) (cont.)**

**External extension H2**

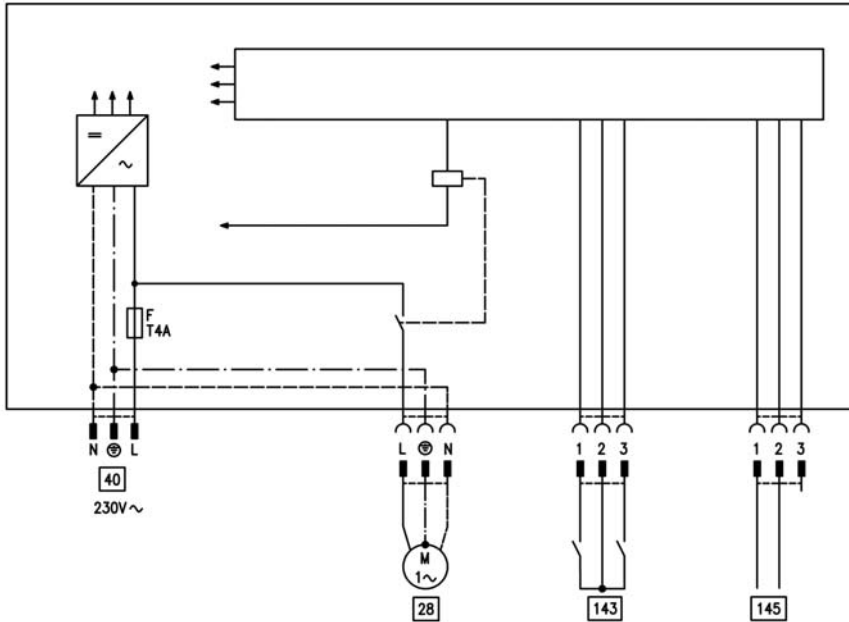

The external extension is connected to the boiler control unit via the KM BUS. The following functions can be controlled or processed via this extension:

- 28 DHW circulation pump
- 40 Power supply

- 143 ■ External blocking (terminals 2 - 3)
- External demand (terminals 1 - 2)
- External operating mode changeover (terminals 1 - 2)

- 145 KM BUS

The allocation of the "External changeover of operating mode" function is selected via coding address 91.

Function description

## Control functions

### External operating mode changeover

The "External operating mode changeover" function is connected via external extension input [143]. With coding address 91 you can select the heating circuit to which the changeover of operating mode should apply:

Coding	Changeover of operating mode affects:
91:0	No changeover
91:1	Heating circuit without mixer (A1)
91:2	Heating circuit with mixer (M2)
91:3	Heating circuit without mixer and heating circuit with mixer

With coding address d5, you can select in which direction the changeover should be made for each heating circuit:

Coding	Changeover of operating mode affects:
d5:0	Changeover towards "Constantly reduced" or "Constant standby mode" (subject to the selected set value)
d5:1	Changeover towards "Constant heating mode"

You can select the duration of the operating mode changeover with coding address F2.

Coding	Changeover of operating mode affects:
F2:0	No changeover of operating mode
F2:1 to F2:12	Duration of the operating mode changeover 1 to 12 hours

The changeover of operating mode remains active as long as the contact remains closed, but no less than the default duration selected with coding address F2.

## Control functions (cont.)

### External blocking

The "External blocking" function is connected via the external extension input 143.

In coding address 32 you can select the influence the signal "Ext. blocking" should have on the connected circulation pumps.

### External demand

The "External demand" function is connected via the external extension input 143".  
In coding address 34 you can select the influence the signal "Ext. demand" should have on the connected circulation pumps.

In coding address 9b, you can select the minimum set boiler water temperature in case of external demand.

### Venting program

#### **Note**

*Close the gas shut-off valve when operating the venting program.*

During the venting program, the circulation pump will be alternately switched ON and OFF for 30 seconds respectively over a period of 20 minutes.

The burner is switched OFF during the venting program.  
The venting program is activated via coding address 2F:1. The program is automatically deactivated after 20 minutes, and the coding address is set to 0.

### Filling program

#### **Note**

*Close the gas shut-off valve when operating the filling program.*

## Function description

### Control functions (cont.)

#### Filling with the control unit switched ON

If the system is to be filled with the control unit switched ON, the pump will be started via coding address 2F:2. The burner shuts down if this function is activated via coding address 2F. The program is automatically deactivated after 20 minutes, and the coding address is set to 0.

#### Screed function

The screed drying functions enables the drying of a freshly laid screed. For this, always observe the instructions issued by the screed manufacturer.

Various temperature profiles are available for selection.

#### Temperature profile: Diagram 1 (DIN 4725 part 4) code F1:1

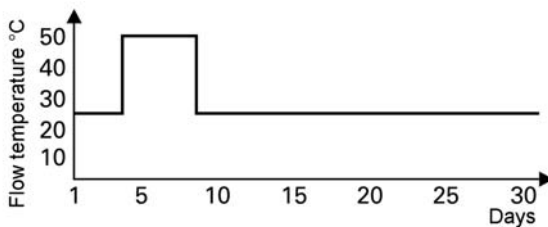

#### Temperature profile: Diagram 2 code F1:2

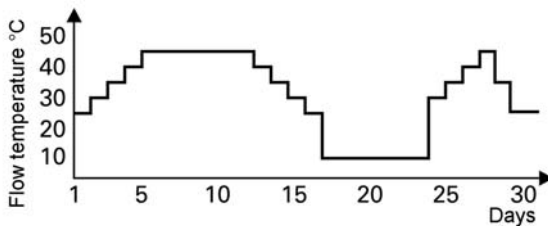



**Control functions (cont.)**

**Temperature profile: Diagram 3 code F1:3**

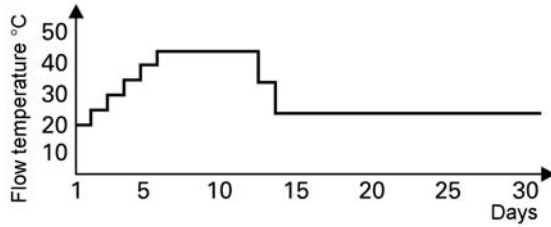

**Temperature profile: Diagram 4 code F1:4**

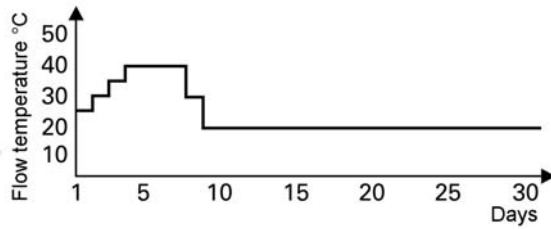

**Temperature profile: Diagram 5 code F1:5**

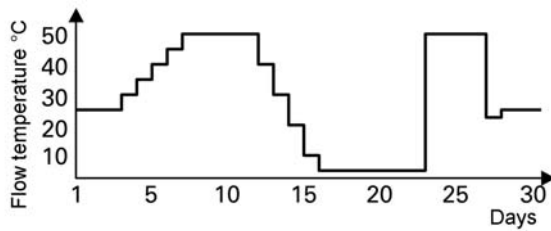

Function description

## Control functions (cont.)

Temperature profile: Factory-set code F1:6 to F1:15

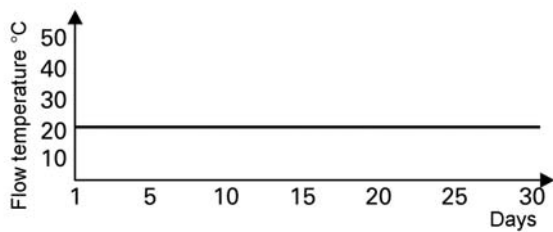

Connection and wiring diagrams – internal connections

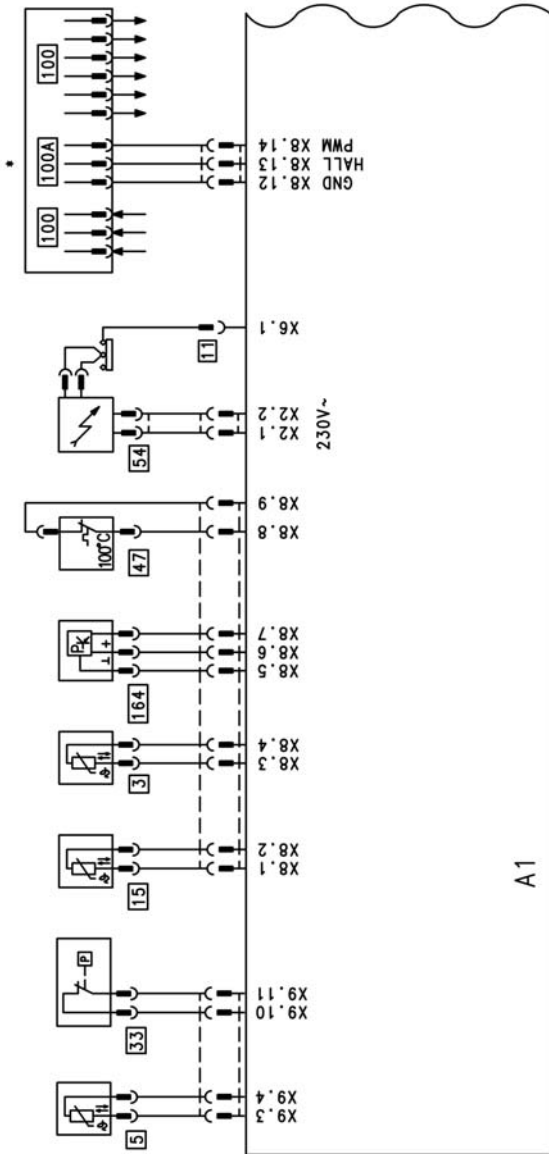

5692.550.GB

A1 Main PCB  
 3 Boiler temperature sensor

5 Cylinder temperature sensor  
 11 Ionisation electrode



## Designs

### Connection and wiring diagrams – internal connectio . . . (cont.)

**15** Flue gas temperature sensor  
**33** Flow switch  
**47** Temperature limiter

**54** Ignition unit  
**100** Fan motor  
**164** Differential pressure sensor

Connection and wiring diagrams – external connections

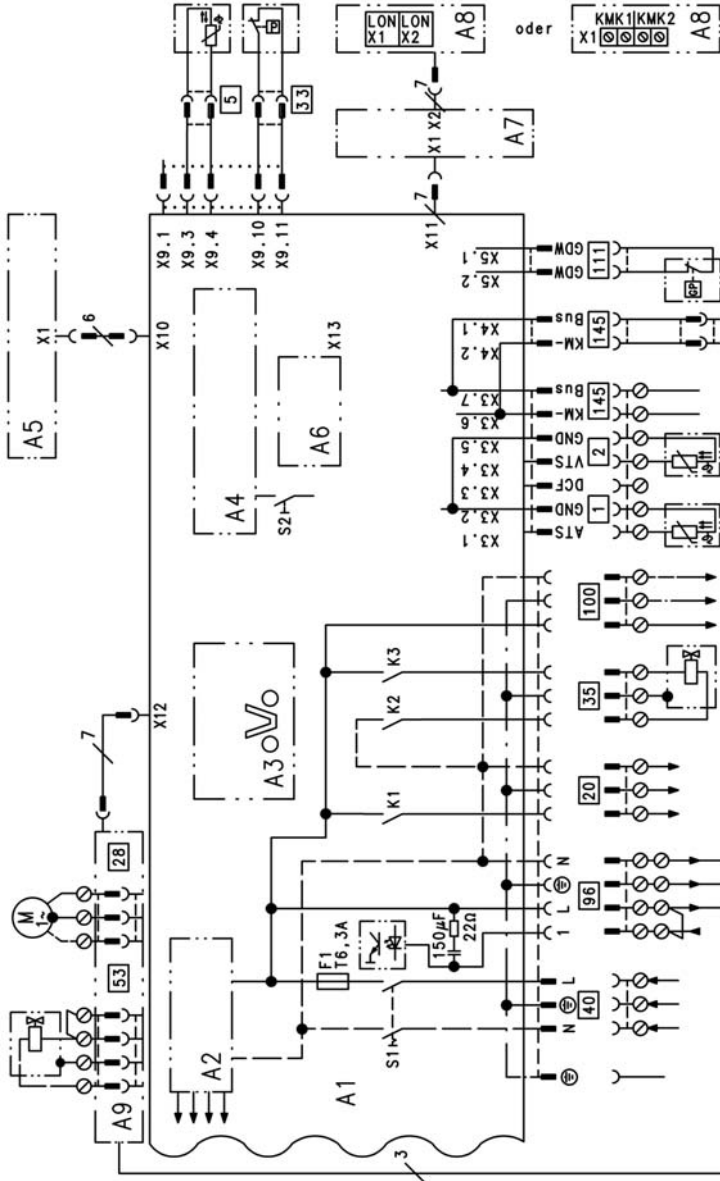

5692.550.GB

A1 Main PCB

A2 Mains supply unit



## Designs

### Connection and wiring diagrams – external connectio . . . (cont.)

A3	Optolink	20	Internal circulation pump (heating circuit pump or boiler circuit pump)
A4	Burner control unit	28	Circulation pump or central fault message
A5	Operating interface	33	Flow switch
A6	Coding card	35	Gas solenoid valve
A7	Connection adaptor	40	Power supply
A8	LON communication module	53	External LPG safety valve
A9	Internal extension H1	96	Mains power supply - acces- sories and Vitotrol 100
S1	ON/OFF switch	100	Fan motor
S2	Reset button	111	Gas governor
1	Outside temperature sensor	145	KM BUS
2	Flow temperature sensor low loss header		
5	Cylinder temperature sensor		

## Parts lists

### Spare parts information

Quote the type and serial no. (see type plate) and the item no. of the required part (as per this parts list).

Obtain standard parts from your local supplier.

- |   |   |
|---|---|
| 006 Burner (with item 007, 009 to 019, 021, 022, 023 and 046) | 044 Pressure gauge and fem. connection                        |
| 007 Burner gauze assembly                                     | 046 Differential pressure sensor                              |
| 008 Electronic box – radial fan                               | 047 Grommet   |
| 009 Radial fan  | 048 Safety springs  |
| 012 Gas pipe (incl. gaskets)                                  | 049 Thermocouple  |
| 013 Conversion kit for natural gas E (gas restrictor)         | 050 Temperature sensor  |
| 014 Conversion kit for natural gas LL (gas restrictor)        | 052 Expansion vessel connection                               |
| 015 Conversion kit for LPG (gas restrictor)                   | 054 Locking bracket   |
| 016 Gas train   | 055 Gravity brake   |
| 017 Ignition unit   | 056 Flue gas temperature sensor                               |
| 018 Gas pipe  | 057 Vitodens control unit                                     |
| 019 Burner insulating ring                                    | 058 Rear cover  |
| 021 Burner gauze assembly gasket, large                       | 059 Support   |
| 022 Burner profile packing                                    | 060 Damper  |
| 023 Burner gauze assembly gasket                              | 061 Pressure gauge retainer                                   |
| 024 Heat exchanger  | 062 Clip  |
| 025 Boiler adaptor  | 063 Hinge   |
| 026 Lip seal Ø 150  | 064 Coding card   |
| 027 Lip seal Ø 100  | 065 Fuse  |
| 028 Plug  | 066 Operating interface for constant temperature operation    |
| 029 Quick-acting air vent valve                               | 067 Operating interface for weather-compensated operation     |
| 030 Grommet   | 069 Outside temperature sensor                                |
| 031 Flow switch   | 090 Micro switch  |
| 032 Diaphragm safety valve                                    |   |
| 033 Siphon  | <b>Wearing parts</b>  |
| 034 Condensate hose   | 010 Ignition electrode  |
| 035 Ball valve  | 011 Ionisation electrode                                      |
| 036 Return pipe extension                                     |   |
| 037 Sealing panel   | <b>Parts not shown</b>  |
| 038 Edge protector  | 001 Operating instructions for constant temperature operation |
| 039 Front panel   | 002 Operating instructions for weather-compensated operation  |
| 042 Wall mounting fixture                                     | 003 Service instructions                                      |
|   | 005 Installation instructions                                 |



## Parts lists

### Parts lists (cont.)

- |   |  |
|---|--|
| 020 Set of small burner parts               | 075 Cable harness X8/X9                |
| 040 Touch-up spray paint, Vitowhite         | 076 Mains cable - motor electronics    |
| 041 Touch-up paint stick, Vitowhite         | 077 Connecting cable - motor           |
| 045 Special grease                          | 078 Internal ionisation lead           |
| 051 Gasket set                              | 079 Cable harness aux. earth/54/35     |
| 053 Heat conducting paste                   | 080 Cable harness ionisation/KM<br>BUS |
| 070 Access guard                            | Ⓐ Type plate                           |
| 074 Test adaptor ionisation current<br>test |  |



**Parts lists** (cont.)

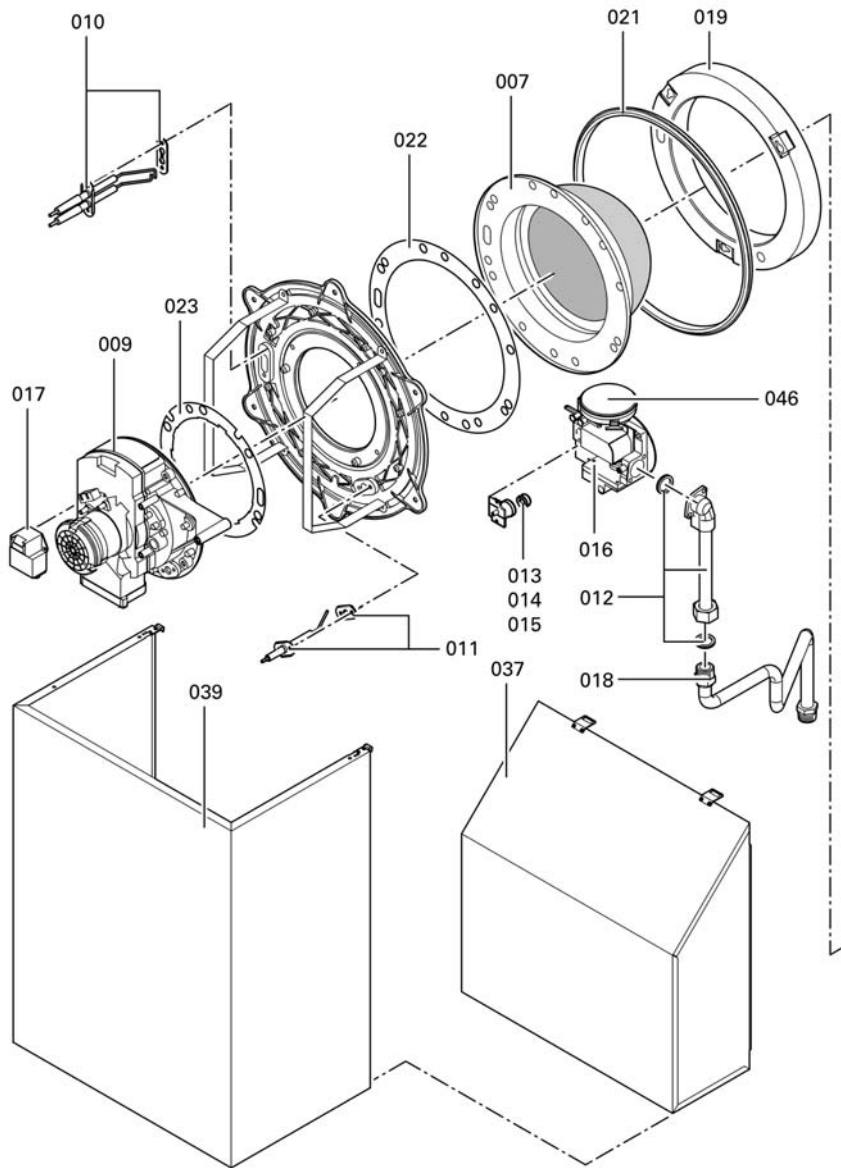

**Parts lists** (cont.)

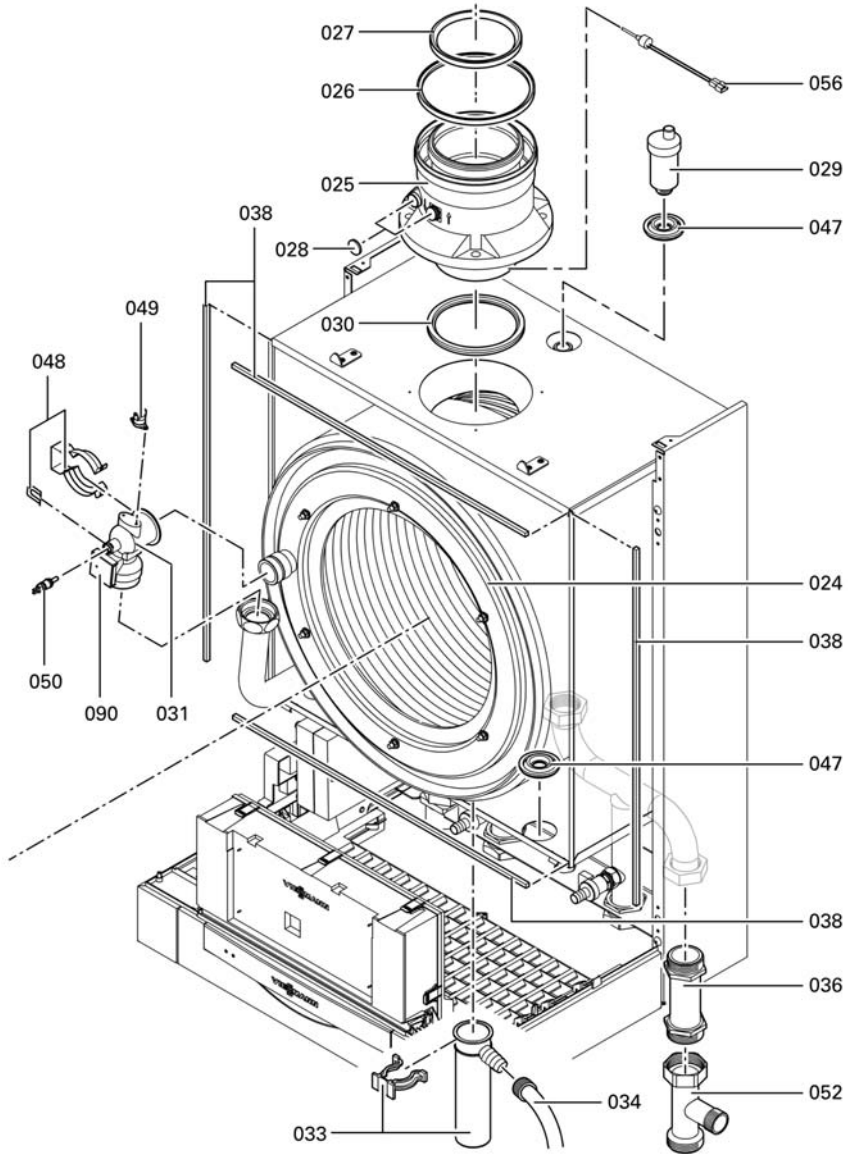

**Parts lists** (cont.)

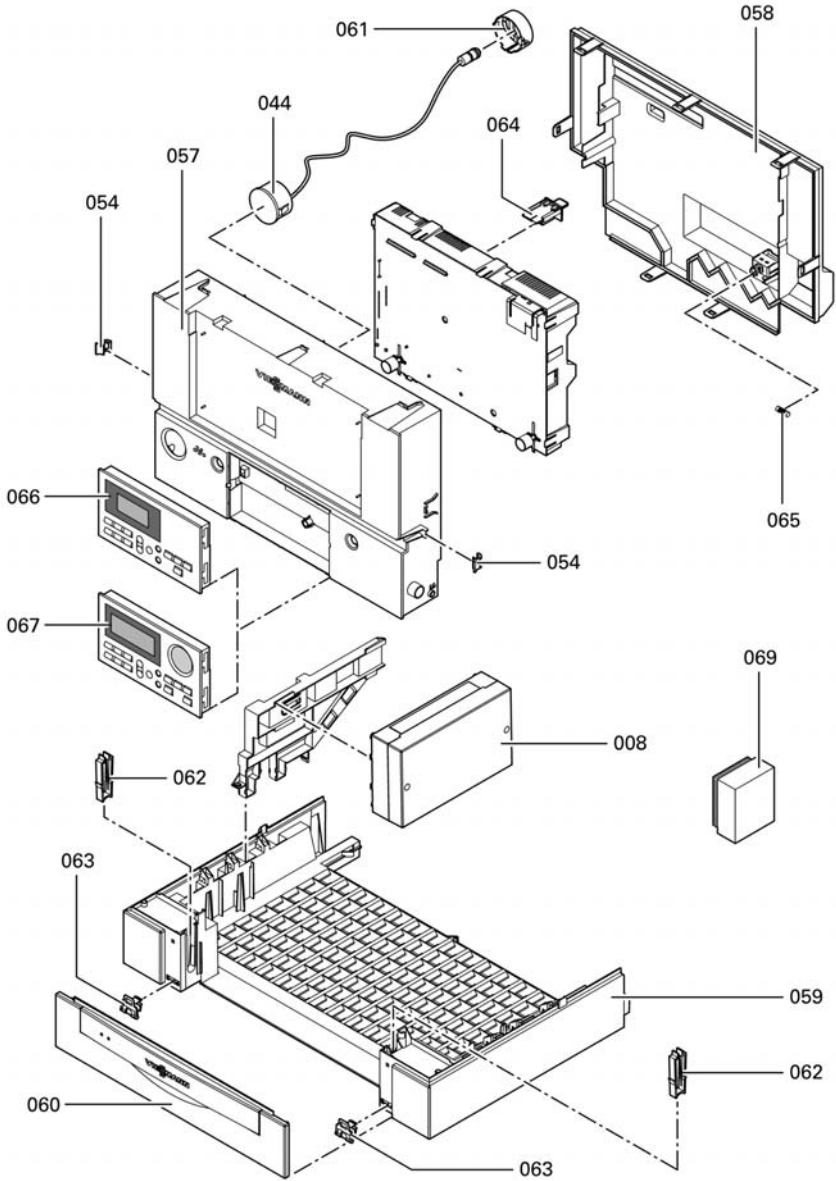

**Parts lists** (cont.)

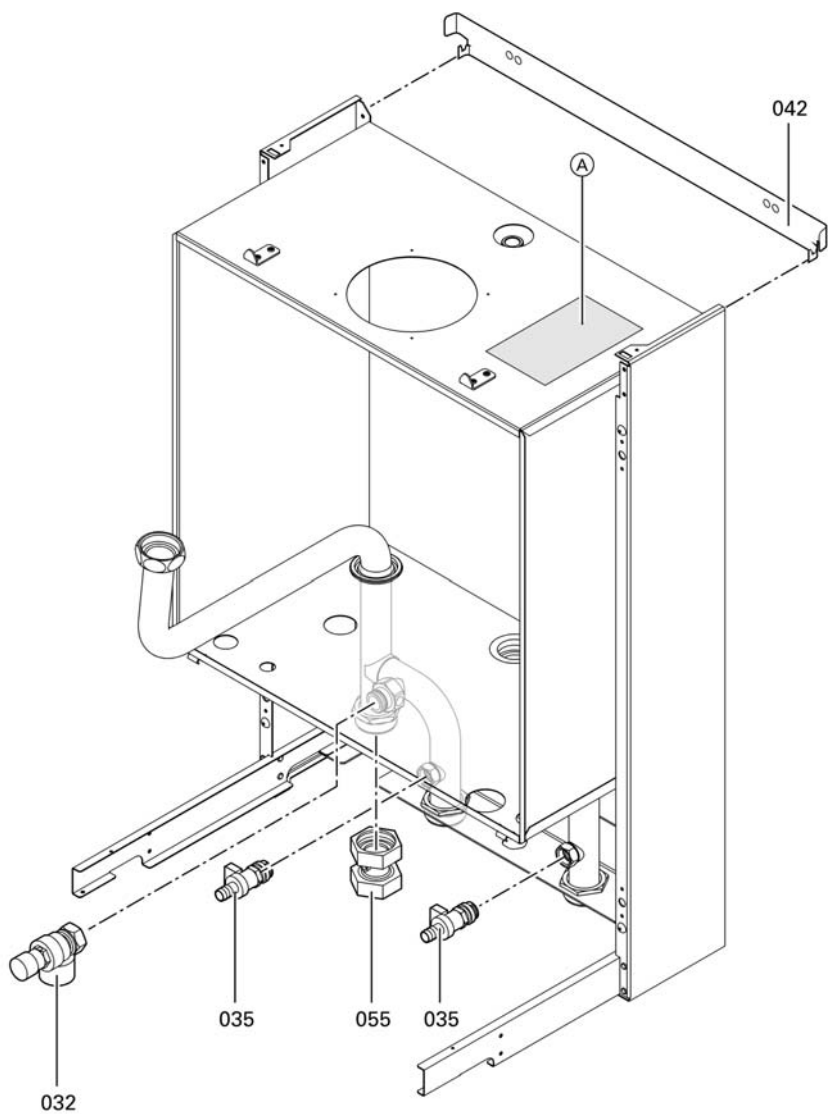

**Parts lists** (cont.)

**Commissioning/service reports**

<b>Setting and test values</b>	<b>Set value</b>	<b>Initial start-up</b>
<b>Date:</b>		
<b>By:</b>		
<b>Static pressure</b>	<i>mbar</i>	max. 57.5 mbar
<b>Supply pressure (flow pressure)</b>		
<input type="checkbox"/> for natural gas E	<i>mbar</i>	17.4 to 57.5 mbar
<input type="checkbox"/> for natural gas LL	<i>mbar</i>	17.4 to 57.5 mbar
<input type="checkbox"/> for LPG	<i>mbar</i>	42.5 to 57.5 mbar
<i>Tick gas type</i>		
<b>Carbon dioxide content CO<sub>2</sub></b>		
■ at lower rated output	<i>% by vol.</i>	
■ at upper rated output	<i>% by vol.</i>	
<b>Oxygen content O<sub>2</sub></b>		
■ at lower rated output	<i>% by vol.</i>	
■ at upper rated output	<i>% by vol.</i>	
<b>Carbon monoxide content CO</b>		
■ at lower rated output	<i>ppm</i>	
■ at upper rated output	<i>ppm</i>	
<b>Ionisation current</b>	<i>µA</i>	min. 5 µA



Commissioning/service reports

**Commissioning/service reports (cont.)**

<b>Setting and test values</b>	<b>Set value</b>	<b>Maintenance/ service</b>
<b>Date:</b>		
<b>By:</b>		
<b>Static pressure</b>	<i>mbar</i>	max. 57.5 mbar
<b>Supply pressure (flow pressure)</b>		
<input type="checkbox"/> for natural gas E	<i>mbar</i>	17.4 to 57.5 mbar
<input type="checkbox"/> for natural gas LL	<i>mbar</i>	17.4 to 57.5 mbar
<input type="checkbox"/> for LPG	<i>mbar</i>	42.5 to 57.5 mbar
<i>Tick gas type</i>		
<b>Carbon dioxide content CO<sub>2</sub></b>		
■ at lower rated output	<i>% by vol.</i>	
■ at upper rated output	<i>% by vol.</i>	
<b>Oxygen content O<sub>2</sub></b>		
■ at lower rated output	<i>% by vol.</i>	
■ at upper rated output	<i>% by vol.</i>	
<b>Carbon monoxide content CO</b>		
■ at lower rated output	<i>ppm</i>	
■ at upper rated output	<i>ppm</i>	
<b>Ionisation current</b>	<i>µA</i>	min. 5 µA





**Commissioning/service reports (cont.)**

<b>Setting and test values</b>	<b>Set value</b>	<b>Maintenance/ service</b>
<b>Date:</b>		
<b>By:</b>		
<b>Static pressure</b>	<i>mbar</i>	max. 57.5 mbar
<b>Supply pressure (flow pressure)</b>		
<input type="checkbox"/> for natural gas E	<i>mbar</i>	17.4 to 57.5 mbar
<input type="checkbox"/> for natural gas LL	<i>mbar</i>	17.4 to 57.5 mbar
<input type="checkbox"/> for LPG	<i>mbar</i>	42.5 to 57.5 mbar
<i>Tick gas type</i>		
<b>Carbon dioxide content CO<sub>2</sub></b>		
■ at lower rated output	<i>% by vol.</i>	
■ at upper rated output	<i>% by vol.</i>	
<b>Oxygen content O<sub>2</sub></b>		
■ at lower rated output	<i>% by vol.</i>	
■ at upper rated output	<i>% by vol.</i>	
<b>Carbon monoxide content CO</b>		
■ at lower rated output	<i>ppm</i>	
■ at upper rated output	<i>ppm</i>	
<b>Ionisation current</b>	<i>µA</i>	min. 5 µA



## Specification

### Specification

Rated voltage:	230 V~	Electronic temperature limiter setting:	81 °C
Rated frequency:	50 Hz	Temperature limiter setting:	100 °C (fixed)
Rated current :	6.3 A~	Mains fuse:	max. 16 A
Safety class:	I		
Protection level:	IP X 4 D to EN 60529		

Permissible ambient temperature	
■ in operation:	0 to +40 °C
■ during storage and transport:	-20 to +65 °C

Power consumption	
■ Burner:	max. 60 W
■ Control unit:	max. 10 VA

### Gas fired boiler, category II 2ELL3P

<b>Rated output</b> Tv/Tr 50/30 °C	<b>kW</b>	<b>12.2 to 49</b>	<b>16.6 to 66</b>
<b>Rated heat load range</b>	<b>kW</b>	11.5 to 46.3	15.6 to 62.2
<b>Connection values*1</b>			
Relative to the max. load with			
	with H <sub>uB</sub>		
Natural gas E	9.45 kWh/m <sup>3</sup> 34.02 MJ/m <sup>3</sup>	m <sup>3</sup> / h	4.90 6.58
Natural gas LL	8.13 kWh/m <sup>3</sup> 29.25 MJ/m <sup>3</sup>	m <sup>3</sup> / h	5.69 7.65
LPG	12.79 kWh/m <sup>3</sup> 46.04 MJ/m <sup>3</sup>	m <sup>3</sup> / h	3.62 4.86
<b>Product ID</b>	CE-0085 BO 0338		

### Product characteristics (to EnEV [Germany])

<b>Rated output range</b>	<b>kW</b>	<b>12.2 to 49</b>	<b>16.6 to 66</b>
<b>Efficiency at</b>			
■ 100 % of rated output	%	97.2	97.3
■ 30 % of rated output	%	107.1	107.3
<b>Standby loss</b> q <sub>B,70</sub> *2	%	0.5	0.4
<b>Power consumption*2 for</b>			
■ 100 % of rated output	W	277	321
■ 30 % of rated output	W	92	107

\*1 The supply values are only for reference (e.g. in the gas contract application) or to estimate the supplementary volumetric settings. Because of factory settings, the gas pressure must not be altered from these values. Reference: 15 °C, 1013 mbar.

\*2 Max. limit to EnEV.

## Declaration of conformity

### Declaration of conformity for Vitodens 300

We, Viessmann Werke GmbH & Co KG, D-35107 Allendorf, declare as sole responsible body, that the product

#### Vitodens 300

**conforms to the following standards:**

DIN 4702-6  
 EN 297  
 EN 483  
 EN 625  
 EN 677  
 EN 50 165  
 EN 60 335  
 EN 61 000-3-2  
 EN 61 000-3-3

**This product is designated in accordance with the following directives:**

90/396/EEC  
 89/336/EEC  
 73/23/EEC  
 92/42/EEC

**as follows:**  
**CE-0085**

EC Declaration of conformity by an authorised body according to EMVG article 10.2 Certificate number: E9 02 08 1730.

This product complies with the requirements of the Efficiency Directive (92/42/EEC) for:

**Condensing boilers**

The product characteristics determined as system values for the product **Vitodens 300 as part of EC type testing according to the Efficiency Directive** (see specification table), can be utilised to assess the energy consumption of heating and ventilation equipment to DIN V 4701-10 which is specified by the EnEV [Germany].

Allendorf, 14.01.04

Viessmann Werk GmbH&Co KG



pp. Manfred Sommer

Certificates

**Manufacturer's certificate according to the 1st BImSchV [Germany]**

We, Viessmann Werke GmbH & Co KG, D-35107 Allendorf, confirm that the following product meets the NO<sub>x</sub> limits specified by 1st BImSchV Paragraph 7 (2) [Germany]:

**Vitodens 300**

Allendorf, 14.01.04

Viessmann Werk GmbH&Co KG

A handwritten signature in black ink, appearing to read 'M. Sommer', is written over the printed name.

pp. Manfred Sommer

## Keyword index

- A**  
 Adjusting the room temperature ..... 35
- B**  
 Boiler temperature sensor ..... 87  
 Brief scans ..... 64  
 Burner gauze assembly ..... 19  
 Burner installation ..... 21  
 Burner removal ..... 18
- C**  
 Checking the differential pressure sensor ..... 90  
 Cleaning agent ..... 21  
 Cleaning the combustion chamber ..... 21  
 Code ..... 38  
 Code 1 ..... 38  
 Code 2 ..... 42  
 Coding during commissioning ..... 24  
 Commissioning ..... 7  
 Condensate drain ..... 22  
 Cylinder temperature sensor ..... 87
- D**  
 Declaration of conformity ..... 125  
 Deleting codes ..... 62
- E**  
 Extension kit for heating circuit with mixer ..... 93  
 Extension  
 ■ external ..... 100, 101  
 ■ internal ..... 98, 99  
 External blocking ..... 103  
 External demand ..... 103
- F**  
 Fault history ..... 73  
 Fault messages ..... 73, 75  
 Filling the system ..... 7  
 Finding faults ..... 74  
 Flue gas temperature sensor ..... 89  
 Function descriptions ..... 95  
 Fuse ..... 92
- G**  
 Gas combination valve ..... 13  
 Gas supply pressure ..... 13  
 Gas type ..... 10
- H**  
 Heating curve ..... 33  
 Heating curve slope ..... 34  
 Heating surfaces ..... 21
- I**  
 Ignition ..... 19  
 Ignition electrodes ..... 19  
 Ionisation current ..... 23  
 Ionisation electrode ..... 19
- L**  
 Language selection ..... 9  
 Level ..... 34  
 Level heating curve ..... 34  
 LON communication module ..... 31  
 LON system ..... 31  
 LON user check ..... 32
- M**  
 Manufacturer's Declaration ..... 126
- O**  
 Operating mode changeover ..... 102  
 Outside temperature sensor ..... 85
- P**  
 Parts list ..... 111  
 Product characteristics ..... 124

## Keyword index

### Keyword index (cont.)

#### R

Relay test .....	68
Resetting the coding to the delivered condition .....	62

#### S

Safety chain .....	90
Scanning .....	64
Scanning operating conditions .....	70
Scanning sensors .....	70
Screed drying .....	104
Screed function .....	104
Service level summary .....	63
Service report .....	118, 120, 122
Setting the date .....	9
Setting the output .....	16
Setting the time .....	9
Setting up LON user numbers .....	31
Siphon .....	22
Slope .....	34
Soundness test, balanced flue system .....	17
Specification .....	124
Static pressure .....	13
Supply pressure .....	12
System designs .....	24, 39
System pressure .....	7

#### T

Temperature scans .....	64
Testing functions .....	68
Testing outputs .....	68
Thermocouple .....	90

#### V

Venting .....	8
Venting program .....	103
Vitotronic 050 .....	94

#### W

Wiring diagrams .....	107
-----------------------	-----









## Applicability

### **12.3 to 49 kW**

#### **Natural gas version**

from serial no.

7176 778 3 00001

#### **LPG version**

from serial no.

7176 780 3 00001

### **16.6 to 66 kW**

#### **Natural gas version**

from serial no.

7176 779 3 00001

#### **LPG version**

from serial no.

7176 781 3 00001

Viessmann Limited

Hortonwood 30, Telford, TF1 7YP, GB

Telephone: +44 1952 675000

Fax: +44 1952 675040

[www.viessmann.co.uk](http://www.viessmann.co.uk)

Printed on environmentally-friendly,  
chlorine-free bleached paper



5692 550 GB Subject to technical modifications